

45

YEARS PRODUCTION

10 YEARS IN
THE UK

USE THE
BLUE
TECHNOLOGY.

PRODUCT CATALOGUE
SEALING SOLUTIONS

ISO
CHEMIE

MODERN SEALING TECHNOLOGY – ESSENTIAL ON THE CONSTRUCTION SITE

The technical requirements for energy-efficient and long-term building seals are increasing all the time. Our innovative product solutions have a positive effect on the energy balance of buildings, at the same time promoting a healthy internal climate. Factors such as airtightness, permanent movement, weather resistance, emissions free, thermal and acoustic insulation as well as humidity and fire protection are important properties of a standard conforming building seal. The constant quality of our sealing systems is monitored regularly by independent institutes according to the very latest standards and regulations.



CONTENT

PRE-COMPRESSED JOINT SEALING TAPES

ISO-BLOCO 600 „PREMIUM EDITION“	4
ISO-BLOCO 600 „COLOUR EDITION“	4
ISO-BLOCO 300 „PREMIUM EDITION“	6
ISO-BLOCO HF	8
ISO-BLOCO T-MAX	10

MULTI-FUNCTIONAL SEALING TAPES

ISO-BLOCO HYBRATEC	12
ISO-BLOCO ONE	14
ISO-BLOCO ONE CONTROL	16
ISO-BLOCO RENO	18
ISO-BLOCO MULTI-FUNCTIONAL TAPE	20
ISO-BLOCO WIN2WALL	22

IN FRONT OF WALL INSTALLATION SYSTEMS

ISO-TOP WINFRAMER „TYPE 1“	24
ISO-TOP WINFRAMER „TYPE 1“ E30	30
ISO-TOP CONSTRUCTION SHEETS WF3	32
ISO-TOP WF FIXINGS	34

WINDOW AND FACADE SEALING FILMS

ISO-CONNECT VARIO SD	36
ISO-CONNECT VARIO XD	38
ISO-CONNECT OUTSIDE EPDM	40
ISO-CONNECT EPDM SEALING COLLAR	42
ISO-CONNECT EPDM SEALING CORNER	42
ISO-CONNECT HB-BAND	44
ISO-CONNECT INSIDE „BLUE LINE“	46
ISO-CONNECT OUTSIDE „BLUE LINE“	48
ISO-CONNECT INSIDE FD	50

PROFILE FILLERS

ISO-PROFIL FILLER STRIPS	52
ISO-PROFIL FILLER PIECES	54

ADHESIVES AND PRIMER

ISO-TOP FLEX-ADHESIVE HP	56
ISO-TOP FLEX-ADHESIVE XP, SP, PA	58
ISO-TOP FLEX-ADHESIVE WF	60
ISO-TOP BLUE PRIMER	62

ISO-TOP SPRAY PRIMER	64
ISO-TOP KSKSEAL PRIMER	66

BUTYL- AND BITUMEN TAPES

ISO-BUTYL ALU TAPE	68
ISO-CONNECT KSKSEAL	70

AIR TIGHT ADHESIVE TAPES

ISO-TOP POWER-TAPE	72
ISO-TOP FLEX-TAPE	74

FIRE PROTECTION PRODUCTS

ISO-FLAME KOMBI F 120	76
ISO-FLAME BRICK S 90	78
ISO-FLAME PLUG S 90	80

MASONRY FILLERS

ISO-BLOCO FILLER	82
------------------	----

CORDS

ISO-ZELL PE-CORD	84
ISO-ZELL PUR-CORD	84

ADHESIVE APPLICATORS & INSTALLATION TOOLS

ISO-TOP PRESSFIX	86
ISO-TOP EASYPRESS	86
ISO-TOP EASYPRESS PRO	86
ISO-TOOL CLIP	87
ISO-TOOL CUT	87

ISO-BLOCO 600 PREMIUM EDITION

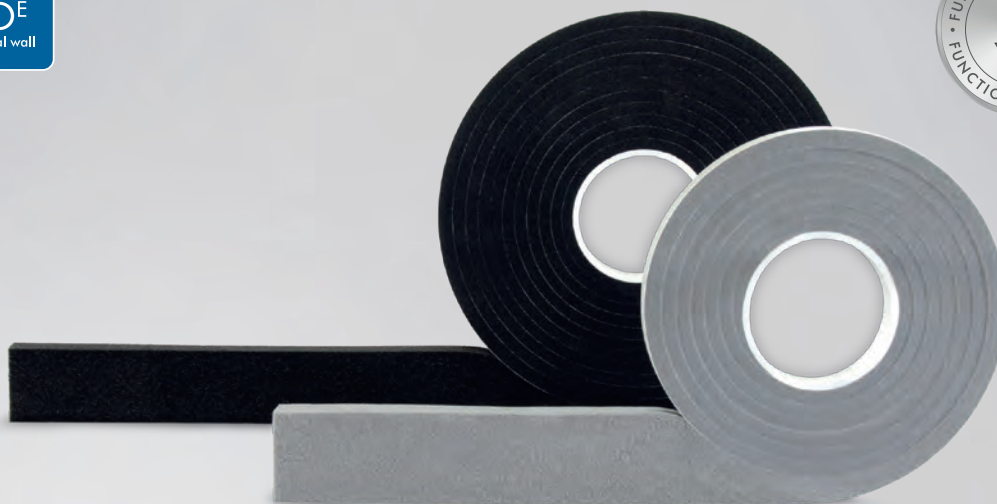

PRODUCT DESCRIPTION

ISO-BLOCO 600 is a PUR sealing tape impregnated with a fire resistant polymeric dispersion. It is specially designed for joints in buildings up to 100 m high, in accordance with DIN 18055.

ISO-BLOCO 600 fulfils the stringent requirements of the DIN 18542:2020. In addition to providing protection against driving rain to a minimum of 600 Pa (equivalent to wind force 11 – Violent Storm) the vapour permeable joint sealing tape also possesses outstanding thermal and acoustic characteristics, as well as allowing for diurnal movement.

APPLICATION

A versatile product that has a wide range of uses, but generally for sealing construction joints (including moving joints) in areas such as between prefabricated concrete, skylights, cladding panels, curtain walling and perimeter seals for fenestration (windows / doors). Used in a variety of construction methods and industries including, general construction & civil engineering, steel and / or timber framed buildings and modular construction.

PACKAGING & SERVICE

- pre-compressed rolls with one side self-adhesive (to aid installation) in cardboard cartons
- standard sizes available from stock
- private label and / or special labelling available

PRODUCT ADVANTAGES

- complies with the DIN 18542 BG 1 / BGR and DIN 18055
- reliability through a wider joint application range
- seals against wind, dust, driving rain
- vapour diffusion permeable
- good adhesive properties, to aid application
- permanently elastic with long term life expectancy
- can be painted over with standard emulsion paints
- compatible with all known standard building materials
- applications in all construction areas and building types are possible
- also available pre-painted as „COLOUR EDITION“
- constant quality to DIN standards, with regular controls from independent institutions
- externally supervised by ift Rosenheim: for driving rain and air permeability (a-value)
- complies with the requirements of the Building Energy Act (EnEV was vaild 31.10.20) and the recommendations of the RAL "installation guide"
- 10 years externally supervised outdoor weathering
- 10 Year Function Warranty*

* On the conditions of the manufacturer (available on request).



Technical data	Standard	Classification
Material description		impregnated PUR flexible foam
Basis		fire resistant polymeric dispersion
Colour		grey, black
Classification, according to	DIN 18542	BG 1 and BGR
Airtightness (External application BG 1)	DIN EN 12114	$a < 1.0 \text{ m}^3 / [\text{h} \cdot \text{m} \cdot (\text{daPa})^{2/3}]$ ift externally supervised
Airtightness (Internal application BGR)	DIN EN 12114	$a < 0.1 \text{ m}^3 / [\text{h} \cdot \text{m} \cdot (\text{daPa})^{2/3}]$ ift externally supervised***
Impermeable to driving rain, single joint	DIN EN 1027	$\geq 600 \text{ Pa}$, externally supervised by ift Rosenheim
Impermeable to driving rain, joint intersection	DIN EN 1027	$\geq 600 \text{ Pa}$
Temperature stability range	DIN 18542	-30°C to +90°C
UV light and weather stability	DIN 18542	requirements fulfilled
Compatibility with adjacent building materials	DIN 18542	requirements fulfilled
Dimension tolerance	DIN 7715 T5 P3	requirements fulfilled
Building material class	DIN 4102	B1 (fire resistant)
Thermal conductivity	DIN EN 12667	$\lambda = 0.043 \text{ W} / \text{m} \cdot \text{K}$
Water vapour diffusion resistance μ	DIN EN ISO 12572	≤ 100
Long term stability		10 year performance guarantee*
ETA - 07/0072		CE mark since 2007
sd-value	DIN EN ISO 12572	$\leq 0.5 \text{ m}$ for 50mm width (vapour diffusion permeability)
Shelf life		2 years, dry and in original packing
Storage temperature		+1°C to +20°C

Tape width / area of application	Recommended BG 1 joint width**	Carton (metres)
8 / 1 – 2mm		740.0
10 / 1 – 2mm	1 – 2mm	600.0
15 / 1 – 2mm		400.0
10 / 1 – 4mm		390.0
15 / 1 – 4mm	1 – 4mm	260.0
20 / 1 – 4mm		195.0
10 / 2 – 6mm		360.0
15 / 2 – 6mm	2 – 6mm	240.0
20 / 2 – 6mm		180.0
10 / 4 – 9mm		240.0
15 / 4 – 9mm	4 – 9mm	160.0
20 / 4 – 9mm		120.0
12 / 5 – 12mm		140.0
15 / 5 – 12mm	5 – 12mm	112.0
20 / 5 – 12mm		84.0
15 / 6 – 15mm		86.0
20 / 6 – 15mm	6 – 15mm	64.5
30 / 6 – 15mm		43.0
20 / 9 – 20mm		49.5
25 / 9 – 20mm	9 – 20mm	39.6
30 / 9 – 20mm		33.0
25 / 11 – 25mm		31.2
30 / 11 – 25mm	11 – 25mm	26.0
35 / 18 – 34mm		26.4
40 / 18 – 34mm	18 – 34mm	23.1
40 / 24 – 42mm		18.2
50 / 24 – 42mm	24 – 42mm	15.6



ISO-BLOCO 600 COLOUR EDITION

ISO-BLOCO 600 „COLOUR EDITION“ makes it possible to achieve stunning colour effects with structural joints in buildings up to 100 m high, saving the painstaking work of over painting. The product's excellent properties retain all the proven benefits of pre-compressed joint sealing tapes and BG1 certification, which is proof that the permanently elastic tape can be used in external joints that are directly exposed to the weather.



Alternative dimensions available on request.

** Movement in structural elements and temporary longitude changes are to be taken into account by the max. joint width.

*** In BGR tested gap dimensions.

ISO-BLOCO 300 PREMIUM EDITION

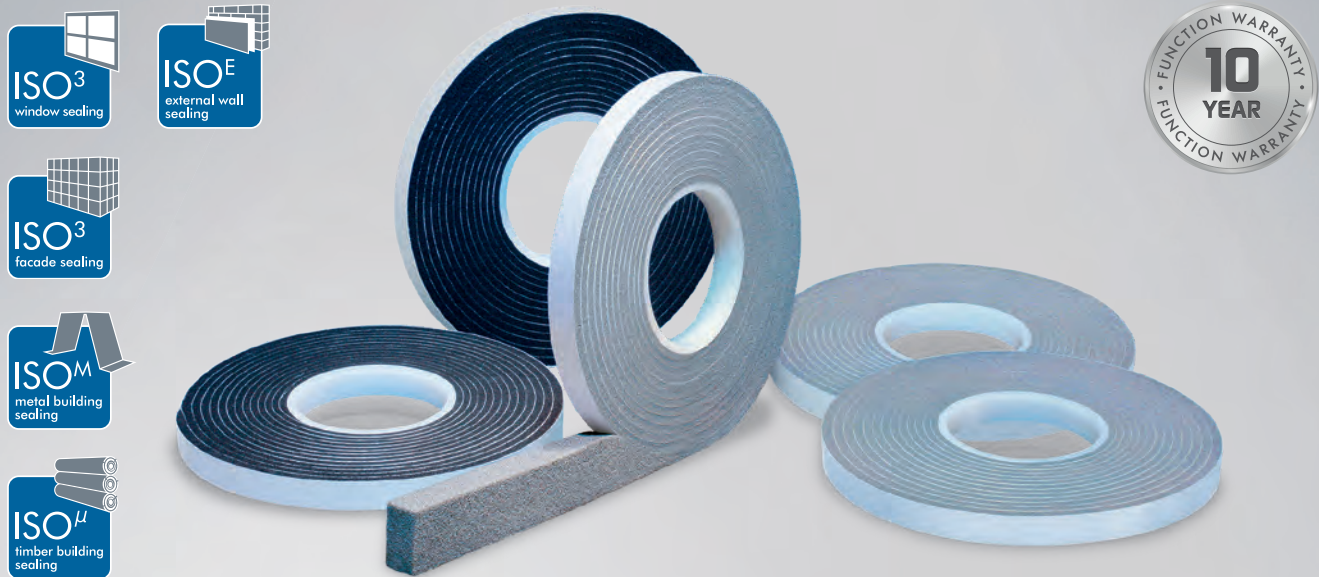

PRODUCT DESCRIPTION

ISO-BLOCO 300 is a polymer dispersion impregnated PUR sealing tape. In its compressed state it is ideal for use against driving rain, dust and drafts. With the appropriate compression, it offers a reliable protection against driving rain to a minimum of 300Pa (this is equivalent to strong gale force 9). ISO-BLOCO 300 can also be used as sound insulation. It meets the high qualification requirements for the BG2 classification, in accordance with DIN 18542:2020.

APPLICATION

ISO-BLOCO 300 is suitable for sealing joints and connections in building constructions and facades. It is particularly suitable for applications involving windows, metal, masonry, wood and drywall constructions. ISO-BLOCO 300 can also be used as a thermal barrier tape.



PRODUCT ADVANTAGES

- complies with DIN 18542 BG2 and UK Building Regulations
- seals against driving rain, wind and dust
- permanently elastic with life long movement capacity
- vapour diffusion permeable – breathable
- thermal and acoustic insulating properties
- self-adhesive to aid installation / location
- can be painted with standard emulsion paints
- compatible with all known building materials / areas
- constant quality control to DIN standards
- complies with the requirements of the Building Energy Act (EnEV was valid 31.10.20) and the recommendations of the RAL "installation guide"
- 10 Year Function Warranty*

* On the conditions of the manufacturer (available on request).



Technical data	Standard	Classification
Material description		impregnated PUR flexible foam
Impregnant		fire resistant polymeric dispersion
Colour		grey, black
Classification, according to	DIN 18542	BG2
Air permeability coefficient	DIN EN 12114	$\alpha < 1.0 \text{ m}^3 / [\text{h} \cdot \text{m} \cdot (\text{daPa})^n]$
Impermeable to driving rain, single joint	DIN EN 1027	$\geq 300 \text{ Pa}$
Temperature stability range	DIN 18542	-30°C to +90°C
UV light and weather stability	DIN 18542	requirements fulfilled
Compatibility with adjacent building materials	DIN 18542	requirements fulfilled
Dimension tolerance	DIN 7715 T5 P3	requirements fulfilled
Building material class	DIN 4102	B1 (fire resistant)
Thermal conductivity	DIN EN 12667	$\lambda = 0.052 \text{ W/m} \cdot \text{K}$
Water vapour diffusion resistance μ	DIN EN ISO 12572	≤ 100
ETA - 07/0073		CE mark since 2007
sd-value	DIN EN ISO 12572	$\leq 0.5 \text{ m}$ for 50 mm width (vapour diffusion permeability)
Shelf life		1 year, dry and in original packing
Storage temperature		+1°C to +20°C

Tape width / area of application	Recommended joint width*	Carton (metres)
8 / 1 – 2 mm		740.0
10 / 1 – 2 mm	1 – 2 mm	600.0
15 / 1 – 2 mm		400.0
10 / 1 – 4 mm		390.0
15 / 1 – 4 mm	1 – 4 mm	260.0
20 / 1 – 4 mm		195.0
10 / 2 – 6 mm		360.0
15 / 2 – 6 mm	2 – 6 mm	240.0
20 / 2 – 6 mm		180.0
10 / 4 – 9 mm		240.0
15 / 4 – 9 mm	4 – 9 mm	160.0
20 / 4 – 9 mm		120.0
12 / 5 – 12 mm		140.0
15 / 5 – 12 mm	5 – 12 mm	112.0
20 / 5 – 12 mm		84.0
15 / 6 – 15 mm		86.0
20 / 6 – 15 mm	6 – 15 mm	64.5
30 / 6 – 15 mm		43.0
20 / 9 – 20 mm		49.5
25 / 9 – 20 mm	9 – 20 mm	39.6
30 / 9 – 20 mm		33.0
25 / 11 – 25 mm		31.2
30 / 11 – 25 mm	11 – 25 mm	26.0
40 / 11 – 25 mm		18.2

Alternative dimensions available on request.

* Movement in the structure and temporary longitude changes are to be taken into account when determining the max. joint width.

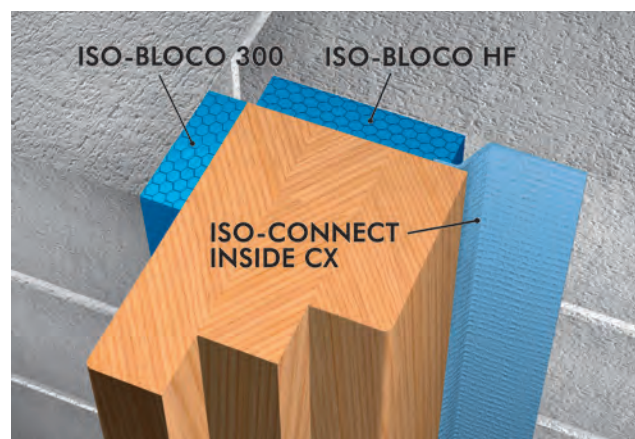

Installation example: ISO³-WINDOW SEALING SYSTEM

SERVICE

- standard sizes available from stock
- private label and / or special labelling available
- non-standard widths available on request
- competent experienced technical support available in the field and by phone

PACKAGING

pre-compressed rolls with one side self-adhesive (to aid installation) in cardboard cartons

ISO-BLOCO HF



PRODUCT DESCRIPTION

ISO-BLOCO HF is an impregnated sealing tape, which under compression, is suitable for thermal and acoustic insulation as well as sealing against drafts and dust.

APPLICATION

ISO-BLOCO HF can be used between window couplings or in the perimeter joints between assorted building elements. It is also outstanding as thermal insulation in construction joints, as an excellent substitute to conventional can foams. However above all it is characterised for its thermal and acoustic insulating properties.

SERVICE

- standard sizes available from stock
- private label and / or special labelling available
- non-standard widths available on request
- competent experienced technical support available in the field and by phone

PACKAGING

pre-compressed rolls with one side self-adhesive (to aid installation) in cardboard cartons

PRODUCT ADVANTAGES

- particularly ideal as a sealing and insulation layer in conjunction with the ISO³-WINDOW SEALING SYSTEM
- permanently elastic, providing a constant high level of acoustic and thermal insulation
- vapour diffusion permeable – breathable
- self-adhesive to aid installation / location
- compatible with all established sealant compounds
- low temperature expansion
- constant quality control to DIN standards
- complies with the requirements of the Building Energy Act (EnEV was valid 31.10.20) and the recommendations of the RAL “installation guide”
- 10 Year Function Warranty*

* On the conditions of the manufacturer (available on request).



Installation example: ISO-BLOCO HF



ISO-BLOCO T-MAX

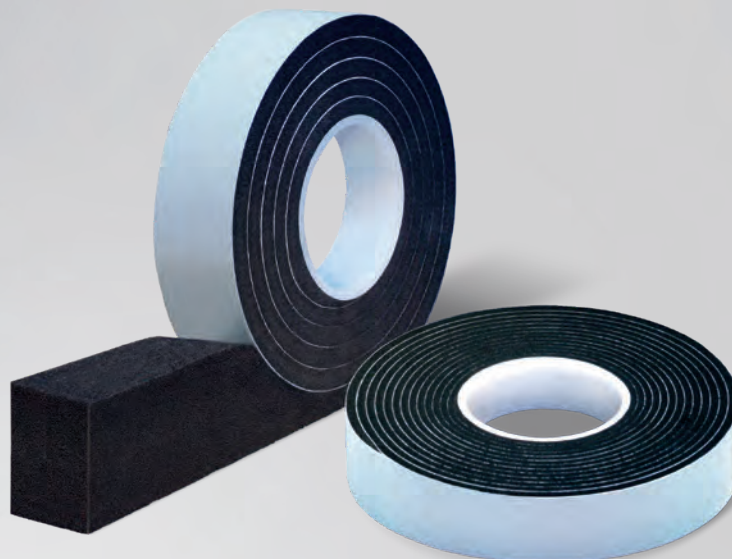

PRODUCT DESCRIPTION

ISO-BLOCO T-MAX is a special PUR sealing tape impregnated with a fire resistant polymeric dispersion. It is specifically designed for larger joints which require large movement accommodation. In addition to supplying a weather tight seal against wind driven rain it also has thermal and acoustic insulation properties, complying with UK Building Regulations. ISO-BLOCO T-MAX is particularly well suited for multistory timber framed buildings where a large amount of differential movement is expected between fenestration or roofs and the external facades, allowing up to 39mm of movement, with a single tape. Ideal for window head or cill and under roof eaves.

APPLICATION

A versatile product that has a wide range of uses, but generally for sealing construction joints (including larger movement joints) in areas such as:

- external facade seals on timber framed buildings
- prefabricated concrete, and other material, elements (including civil engineering)
- perimeter seals for fenestration (windows / doors)
- cladding panels
- curtain walling

Used in a variety of construction methods and industries including:

- timber and / or steel framed buildings
- general construction and civil engineering
- modular construction and other MMC types

PRODUCT ADVANTAGES

- fulfils UK Building Regulations and RAL recommendations
- seals against driving rain, snow, wind and dust
- accommodates up to 39 mm of movement (> 350% MAF)
- fit and forget – no remedial visits after large movement, unlike wet sealants
- perfectly flat visual surface finish
- vapour permeable – breathable
- thermal and acoustic insulating properties
- self-adhesive to aid installation / location
- permanently elastic with long life expectancy
- can be painted with standard emulsion paints
- compatible with all known building materials
- constant quality control to DIN EN ISO 9001 and DIN standards

SERVICE

- standard sizes available from stock
- non standard lengths and widths available on request
- competent experienced technical support available in the field and by phone



Technical data	Standard	Classification
Material description		impregnated PUR flexible foam
Impregnant		acrylic with flame retarding additives
Colour		black
Air permeability coefficient	DIN EN 12114	$\alpha \leq 1.0 \text{ m}^3 / [\text{h} \cdot \text{m} \cdot (\text{daPa})^0.5]$
Impermeable to driving rain, single joint	DIN EN 1027	$\leq 450 \text{ Pa}$
Temperature stability range	DIN 18542	-30°C to +90°C
UV light and weather stability	DIN 18542	requirements fulfilled
Compatibility with adjacent building materials	DIN 18542	requirements fulfilled
Dimension tolerance	DIN 7715 T5 P3	requirements fulfilled
Building material class	DIN 4102	B1 (fire resistant)
Thermal conductivity	DIN EN 12667	$\lambda \leq 0.052 \text{ W/m} \cdot \text{K}$
Water vapour diffusion resistance μ	DIN EN ISO 12572	≤ 10
sd-value	DIN EN ISO 12572	$\leq 0.5 \text{ m}$ for 50mm width (vapour diffusion permeability)
Shelf life		2 years, dry and in original packing
Storage temperature		+1°C to +20°C

Tape width / area of application	Recommended joint width*	Roll length (metres)	Carton (metres)
40 / 11 – 40mm	11 – 40mm	2.6	18.2
50 / 11 – 50mm	11 – 50mm	2.6	15.6

Alternative dimensions available on request.

* Movement in the structure is to be taken into account when determining the max. joint width.

PACKAGING

pre-compressed rolls with one side self adhesive (to aid installation) in cardboard cartons

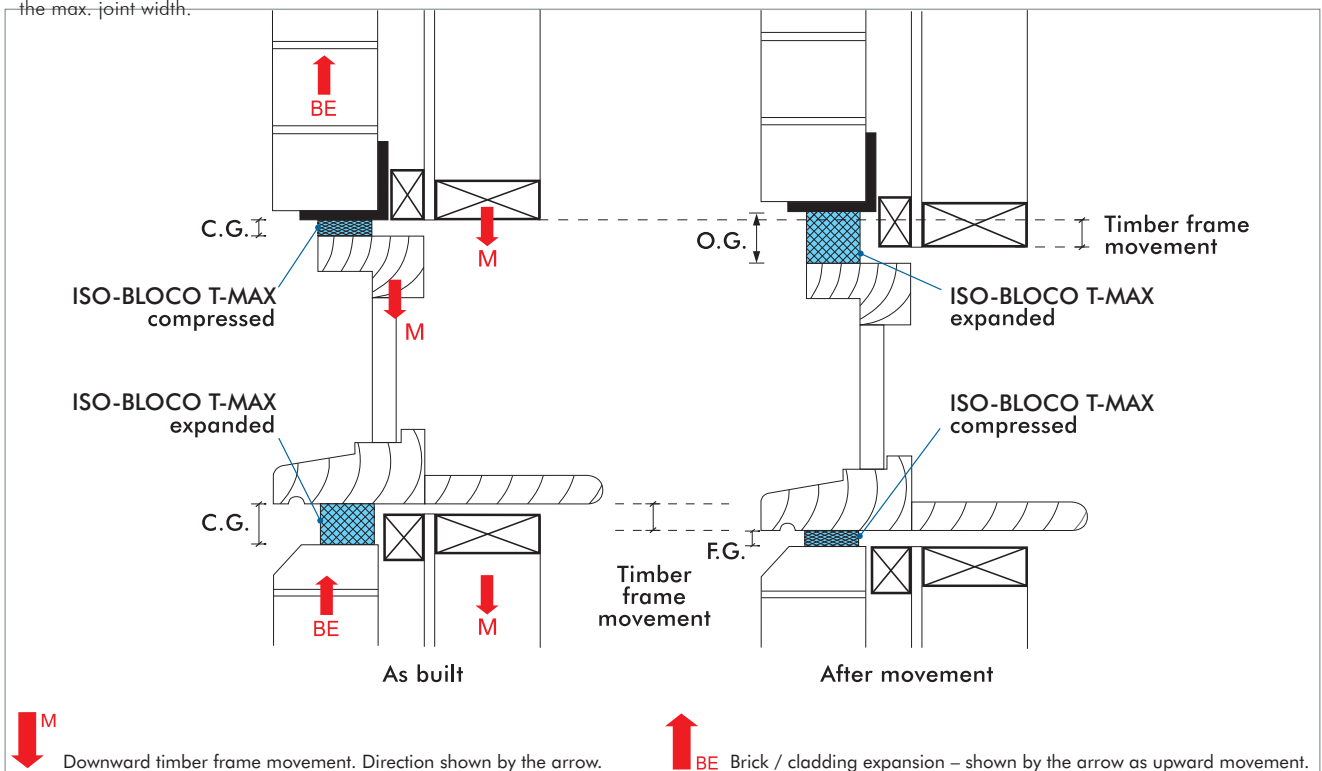
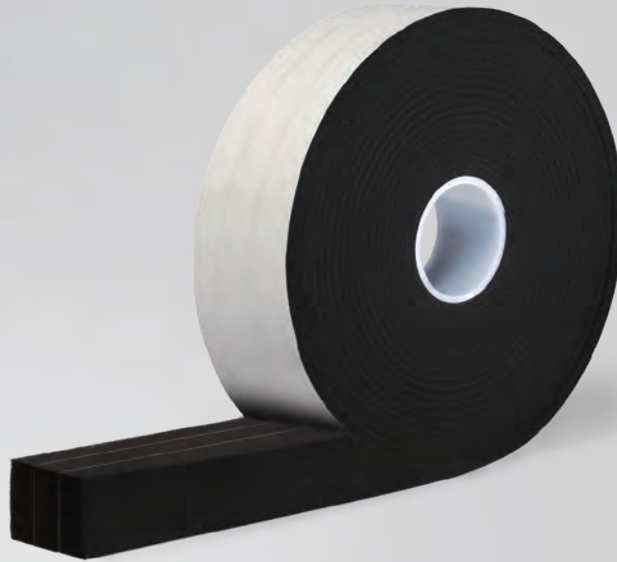

Diagram of window head and cill with masonry cladding showing before and after vertical movement. C.G. Initial Construction Gap – “before”, F.G. Final Gap – post-movement – “after”, O.G. Opened Gap – post-movement – “after”

ISO-BLOCO HYBRATEC



PRODUCT DESCRIPTION

ISO-BLOCO HYBRATEC is a multi-functional tape 4.0 that is equipped with hybrid technology. The new hybrid technology combines the high resistance of film technology to air and driving rain with the reliable flexibility and movement absorption ability of high-quality multi-functional tapes tested and certified to MF1 (previously BG1 and BGR). With an α -value of $0.00 \text{ m}^3 / [\text{h} \cdot \text{m} \cdot (\text{daPa})^n]$, the pre-compressed tape is 100% air tight when used on the interior and thus prevents convection heat losses. By integrating several barrier layers, ISO-BLOCO HYBRATEC complies with the principle “inside tighter than outside”.

APPLICATION

ISO-BLOCO HYBRATEC is the multi-functional tape that meets the requirements of state-of-the-art buildings 100% in terms of energy efficiency and reliability. It offers the absolute airtightness and maximum thermal protection that is mandatory for passive houses and zero-energy houses as well as a high resistance to driven rain that has been adapted to climate change yet still guarantees long-term permanent absorption of movement. ISO-BLOCO HYBRATEC is the suitable multi-functional tape 4.0 for all these requirements.

PACKAGING

Pre-compressed rolls with one side self-adhesive (to aid installation)

PRODUCT ADVANTAGES

- hybrid technology thanks to film barrier layers
- sealing of a wide range of different joints with one tape dimension 6 – 40 mm
- absolutely air tight thanks to several barrier layers of film
- double protection thanks to hybrid technology
- no flow of warm air from the inside to the outside
- maximum energy saving
- resistant to driven rain in excess of 1,050 Pa
- complies with the principle “inside tighter than outside” thanks to several barrier layers of film
- optimum transportation of humidity
- high drying effect
- high functional reliability due to large expansion ability
- certified Passive House component
- complies with the requirements of the Building Energy Act and the recommendations of the RAL “installation guide”
- 10 Year Function Warranty*

* On the conditions of the manufacturer (available on request).

ACCESSORIES

ISO-TOP FLEX-ADHESIVE XP for gluing tape joints



Technical data	Standard	Classification
Material description		impregnated PUR flexible foam with hybrid technology
Colour		black
Impermeable to driving rain	DIN EN 1027	$\geq 1,050\text{Pa}$
Temperature stability range	DIN 18542	-30°C to $+80^{\circ}\text{C}$
Classification according to	DIN 18542-2020	MF 1 (BG 1 / BGR)
Air permeability coefficient	DIN EN 12114	$\alpha = 0.00\text{m}^3/[\text{h} \cdot \text{m} \cdot (\text{daPa})^0]$
Compatible with adjacent building materials	DIN 18542	requirements fulfilled
Dimension tolerance	DIN 7715 TP P3	requirements fulfilled
Building material class	DIN 4102	B1 (fire resistant)
Thermal conductivity	DIN EN 12667	$\lambda_{10,\text{tr}} \leq 0.048\text{W}/\text{m} \cdot \text{K}$
U-value: window construction depth 60mm / 70mm / 80mm	DIN 4108-3	$U = 0.8\text{W}/(\text{m}^2 \cdot \text{K}) / 0.7\text{W}/(\text{m}^2 \cdot \text{K}) / 0.6\text{W}/(\text{m}^2 \cdot \text{K})$
Sound reduction		up to 60 dB
Humidity management	DIN 4108-3 DIN EN ISO 10077-2	drying consistency thanks to hybrid technology
Shelf life		1 year, dry and in original packing
Storage temperature		$+1^{\circ}\text{C}$ to $+20^{\circ}\text{C}$

Tape width	Recommended joint width*		
	S	M	XL
30 mm	3 – 14 mm	4 – 20 mm	6 – 40 mm
40 mm	3 – 14 mm	4 – 20 mm	6 – 40 mm
55 mm	3 – 14 mm	4 – 20 mm	6 – 40 mm
65 mm	3 – 14 mm	4 – 20 mm	6 – 40 mm
70 mm	3 – 14 mm	4 – 20 mm	6 – 40 mm
75 mm	3 – 14 mm	4 – 20 mm	6 – 40 mm
80 mm	3 – 14 mm	4 – 20 mm	6 – 40 mm
85 mm	3 – 14 mm	4 – 20 mm	6 – 40 mm
95 mm	3 – 14 mm	4 – 20 mm	6 – 40 mm
105 mm	3 – 14 mm	4 – 20 mm	6 – 40 mm

* Movement in structural elements and temporary longitude changes are to be taken into account by the max. joint width.



Installation example: ISO-BLOCO HYBRATEC

ISO-BLOCO ONE

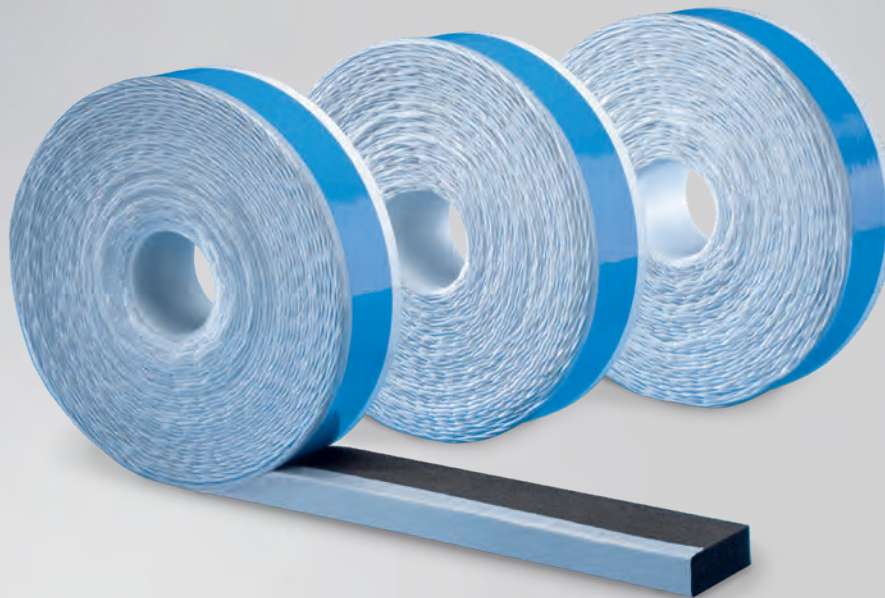

PRODUCT DESCRIPTION

ISO-BLOCO ONE is a special multi-functional all-in-one joint sealing tape with outstanding properties. Having an α -value of $0.00 \text{ m}^3 / [\text{h} \cdot \text{m} \cdot (\text{daPa})^{2/3}]$ the pre-compressed tape is 100% air tight at the internal seal area, contributing in minimising heat loss by convection. It also possesses an optimal vapour diffusion gradient from the inside outwards (40:1) enhancing the external transmission of moisture, enabling the joints to dry out quicker.

APPLICATION

This all-in-one PUR-flexible foam sealant tape combines all the requirements of the Building Energy Act (GEG, EnEV was valid 31.10.20), the RAL "installation guide" and the UK Building Regulations in one product. It is particularly suitable for the reliable, uncomplicated and time saving perimeter sealing of windows and doors. This intelligent joint sealing tape functions around the 3-level-principal. Externally it provides, with more than 750 Pa, high resistance to driven rain, within the middle area it provides thermal and acoustic insulation and internally it is absolutely air tight as well as a water vapour barrier.

SERVICE

- standard sizes available from stock
- competent experienced technical support available in the field and by phone

PRODUCT ADVANTAGES

- 3-level-sealant with just one product
- resistant to driven rain in excess of 750 Pa optimal outwards vapour diffusion
- reduces convection heat loss
- high functional reliability due to large expansion ability
- sealing a wide range of joint sizes with a minimum of tape dimensions
- easy one step application for a reliable seal
- significant cost advantage through time saving installation
- certified Passive House component
- can be installed in adverse weather conditions
- complies with the requirements of the Building Energy Act (EnEV was valid 31.10.20) and the recommendations of the RAL "installation guide"
- 10 Year Function Warranty*

* On the conditions of the manufacturer (available on request).

PACKAGING

pre-compressed rolls with one side self-adhesive (to aid installation) in cardboard cartons



Technical data	Standard	Classification
Material description		impregnated PUR flexible foam with special film
Colour		black
Impermeable to driving rain	DIN EN 1027	≥ 750 Pa
Impermeable to driving rain, joint intersection	DIN EN 1027	MF 1
Temperature stability range	DIN 18542	-30 °C to +80 °C
Classification according to	DIN 18542-2020	MF 1 (BG 1 / BGR)
Airtightness	DIN EN 12114	$\alpha = 0.00 \text{ m}^3 / [\text{h} \cdot \text{m} \cdot (\text{daPa})^{2/3}]^{**}$
UV light and weather stability	DIN EN ISO 4892-2	MF 1
Compatible with adjacent building materials	DIN 52453	requirements fulfilled
Dimension tolerance	DIN 7715 T5 P3	requirements fulfilled
Building material class	DIN 4102	B1 (fire resistant)
Thermal conductivity	DIN EN 12667	$\lambda_{10, \text{tr}} \leq 0.048 \text{ W} / \text{m} \cdot \text{K}$
U-value: window construction depth 60 mm / 70 mm / 80 mm	DIN 4108-3	$U = 0.8 \text{ W} / (\text{m}^2 \cdot \text{K}) / 0.7 \text{ W} / (\text{m}^2 \cdot \text{K}) / 0.6 \text{ W} / (\text{m}^2 \cdot \text{K})$
Sound reduction		up to 56 dB in 10 mm joint
sd-value gradient (from internal to external)	DIN EN ISO 12572	≈ 40:1 (internal ≥ 22; external ≤ 0.5)
ETA - 15/0407		CE mark since 2015
Shelf life		1 year, dry and in original packing
Storage temperature		+1 °C to +20 °C

** no measurable air penetration according to DIN EN 12114.

Tape width / area of application	Window construction depth	Recommended joint width***	Carton (metres)
54 / 2 – 12 mm	60 mm	2 – 12 mm	210.0
64 / 2 – 12 mm	70 mm		180.0
74 / 2 – 12 mm	80 mm		150.0
82 / 2 – 12 mm	90 mm		120.0
54 / 3 – 18 mm	60 mm	3 – 18 mm	140.0
64 / 3 – 18 mm	70 mm		120.0
74 / 3 – 18 mm	80 mm		100.0
82 / 3 – 18 mm	90 mm		80.0
54 / 5 – 30 mm	60 mm	5 – 30 mm	84.0
64 / 5 – 30 mm	70 mm		72.0
74 / 5 – 30 mm	80 mm		60.0
82 / 5 – 30 mm	90 mm		48.0

Alternative dimensions available on request.

*** Movement in structural elements and temporary longitude changes are to be taken into account by the max. joint width.



Installation example: ISO-BLOCO ONE

ACCESSORIES

ISO-TOP FLEX-ADHESIVE PA and ISO-TOP FLEX-ADHESIVE XP



PATENTED

ISO-BLOCO ONE „SET“

ISO-BLOCO ONE „SET“ can be used for construction depths greater than 82 mm. Here, ISO-BLOCO ONE is combined with an extension tape (without inner sealing membrane). The two tapes are bonded parallel on the frame edge with a small gap between them. See our current article list for details of the ISO-BLOCO ONE „SET“ tape dimension combinations available.

ISO-BLOCO ONE CONTROL

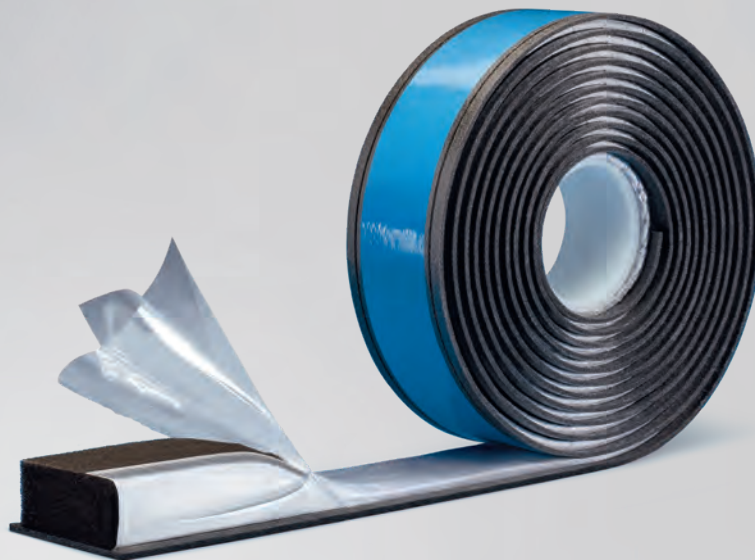

PRODUCT DESCRIPTION

ISO-BLOCO ONE CONTROL is a pre-compressed multi-functional joint sealing tape packed in a tear-off activation film. Designed for sealing windows in accordance with Energy Saving Standards according to the RAL "installation guide". It was developed especially to allow simple and reliable pre-fitting. The tear-off cover ensures that the window sealing tape remains compressed, even when the roll is unwound. ISO-BLOCO ONE CONTROL now makes it possible to pre-fit a 3-level seal in the workshop. The easy-to-use pre-fitted tape packaged in a robust film combines three functional areas based on the RAL 3-level principle. The 1,050 Pa outer area offers particularly high resistance to driving rain, while the middle area provides reliable thermal and acoustic insulation. The inner area with an a-rating of 0.00 guarantees a 100% air tight seal.

ISO-BLOCO ONE CONTROL thus helps to minimise heat losses due to convection as described in the current Energy Saving Standards. It also has an optimum vapour diffusion gradient from inside to outside (40 : 1) creating effective moisture transport to the outside and thus rapid drying of the joint.

ACCESSORIES

- ISO-TOOL Clip for quick and easy pre-fitting on PVC windows frames
- ISO-TOOL Cut special blade for creating reliable corners
- ISO-TOP FLEX-ADHESIVE PA and ISO-TOP FLEX-ADHESIVE XP

PRODUCT ADVANTAGES

- the tape is activated exactly when required for controlled expansion
- cost advantage and time saving due to straight-forward pre-fitting off site
- can be fitted regardless of the temperature or weather conditions and no need for external access
- 3-level seal with just one product and in a single operation
- a wide range of joints can be sealed with just a few tape dimensions
- resistant to driven rain in excess of 1,050 Pa high sd-value gradient, optimum moisture transport to the outside, tested and defined
- internal airtightness minimises heat losses caused by convection
- suitable for passive house construction
- complies with the requirements of the Building Energy Act (EnEV was valid 31.10.20) and the recommendations of the RAL "installation guide"
- 10 Year Function Warranty*

* On the conditions of the manufacturer (available on request).



Technical data	Standard	Classification
Material description		impregnated PUR flexible foam with special film and tear-off activation film
Colour		black
Impermeable to driving rain	DIN EN 1027	$\geq 1,050 \text{ Pa}$
Impermeable to driving rain on joint intersections	DIN EN 1027	$\geq 600 \text{ Pa}$
Temperature stability range	DIN 18542	-30°C to $+80^\circ\text{C}$
Classification according to	DIN 18542-2020	MF 1 (BG 1 / BGR)
Air permeability coefficient	DIN EN 12114	$\alpha = 0.00 \text{ m}^3 / [\text{h} \cdot \text{m} \cdot (\text{daPa})^n]$
Compatible with adjacent building materials	DIN 18542	requirements fulfilled
Dimension tolerance	DIN 7715 T5 P3	requirements fulfilled
Building material class	DIN 4102	B1 (fire resistant)
Thermal conductivity	DIN EN 12667	$\lambda_{10, \text{tr}} \leq 0.05 \text{ W} / \text{m} \cdot \text{K}$
U-value: window construction depth 70 mm / 80 mm / 90 mm	DIN 4108-3	$U = 0.7 \text{ W} / (\text{m}^2 \cdot \text{K}) / 0.6 \text{ W} / (\text{m}^2 \cdot \text{K}) / 0.55 \text{ W} / (\text{m}^2 \cdot \text{K})$
Sound reduction		45 dB in 10 mm joint
sd-value gradient (from internal to external) ETA - 15/0407	DIN EN ISO 12572	$\approx 40:1$ (internal ≥ 22 ; external ≤ 0.5) CE mark since 2015
Shelf life		1 year, dry and in original packing
Storage temperature		$+1^\circ\text{C}$ to $+20^\circ\text{C}$

Maximum time between pre-fitting and installation as per manufacturer's specification.

Tape widths	Window construction depth*	Recommended joint width**
60 – 94 mm***	60 – 96 mm	6 – 20 mm
60 – 94 mm***	60 – 96 mm	8 – 33 mm

Alternative dimensions available on request.

* Check the compatibility list.

** Movement of the components and temporary changes of length of the existing joints should be taken into account when determining the right tape size.

*** Available tape widths correspond to current price lists.



Installation example (CB): Fitting PVC windows



Installation example (1-BT): Fitting wooden windows

APPLICATION

The tape is usually fixed to the PVC windows frames using a clip fixing. The ISO-TOOL CLIP assembly tool is used to clip the ISO-BLOCO ONE CONTROL sealing system safely into the grooves in the window profiles, and mechanically fix it to the window frame. The ISO-TOOL CUT corner tool ensures that the corner loops are shaped reliably. The pre-fitted tape is also available with one or two high-quality self-adhesive butyl fixing strips for use with wooden windows and on narrow profiles under 65 mm deep.

After the window is aligned and fixed in the aperture, the seal is activated by pulling the activation tab which tears open the foil perforations. This allows the seal to expand, securely filling the joint within the recommended joint application area.

PACKAGING

pre-compressed tape on rolls with tear-off cover with integral activation tab

FINISHES

- Finish A: CB
with clip fixing
- Finish B: BT
with self-adhesive butyl fixing
(1-BT) with one butyl-adhesive strip in the middle
(2-BT) with two butyl-adhesive strips on the outer edges

ISO-BLOCO RENO

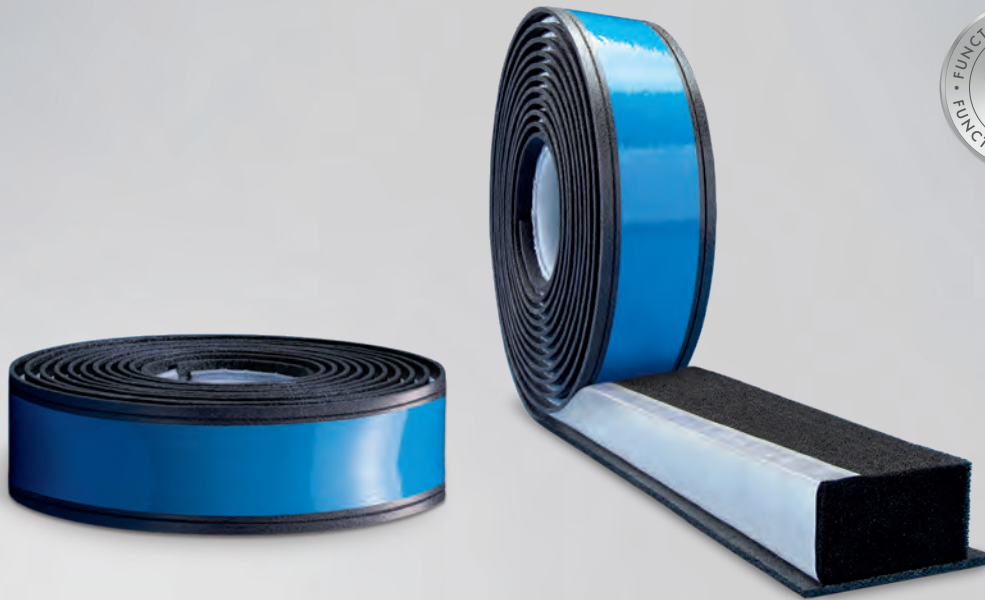

PRODUCT DESCRIPTION

ISO-BLOCO RENO is a multi-functional sealing and insulating system specially developed for energy-related window renovation. It is made up of two connected sealing components. The core layer is made of high-quality polymeric material and provides a smooth surface for the seal. The excellent material component properties guarantee a tight fit in the U-recess which remains after the removal of the old window frame. At the same time as sealing the cavity in the masonry, it forms the basis for the upper sealing layer. The sealing layer is made of impregnated, pre-compressed PUR soft foam with an integrated air tight membrane. The multifunctional material has three distinct areas which combine to achieve the 3-level sealing required by the RAL "installation guide". On the internal side it has an a-value of 0.00, which means it is 100% air tight and acts as a vapour barrier, in the middle area it ensures optimum acoustic and thermal insulation and in the outer area it provides outstanding protection from the weather with a driving rain impermeability of more than 1,050 Pa (Hurricane Forces).

APPLICATION

ISO-BLOCO RENO is excellent for standard-compliant sealing work done during window renovation / replacement. The sealing system is fitted directly into the U-recess left from the removal of the old window before the new window is installed. The fixing process is by means of flexible sealing flanks. To make fitting

PRODUCT ADVANTAGES

- simple and reliable fitting in old buildings
- 3-level seal using only one product
- resistant to driven rain in excess of 1,050 Pa
- reduces convective heat loss
- clean processing without material residue
- high flexibility and application reliability even with joints of different depths
- can be combined with mastic sealing materials and / or cover strips
- installation independent of temperature and the weather
- no change in tried-and-trusted installation processes required for renovation work
- complies with the requirements of the Building Energy Act (EnEV was valid 31.10.20) and the recommendations of the RAL "installation guide"
- 10 Year Function Warranty*

* On the conditions of the manufacturer (available on request).

easier, the tape has also been made self-adhesive. Where U-recesses are particularly deep, we recommend to first back-fill the recess with a suitable insulating material. In addition, ISO-BLOCO RENO is compatible with all known building insulating materials.



Technical data	Standard	Classification
Material description		impregnated PUR flexible foam with special film
Colour		black
Impermeable to driving rain	DIN EN 1027	$\geq 1,050 \text{ Pa}$
Temperature stability range	DIN 18542	-30°C to $+80^\circ\text{C}$
Classification according to	DIN 18542-2020	MF1 (BG 1 and BGR)
Air permeability coefficient	DIN EN 12114	$\alpha = 0.00 \text{ m}^3 / [\text{h} \cdot \text{m} \cdot (\text{daPa})^0]$
Compatible with adjacent building materials	DIN 18542	requirements fulfilled
Dimension tolerance	DIN 7715 T5 P3	requirements fulfilled
Building material class	DIN 4102	B1 (fire resistant)
Thermal conductivity	DIN EN 12667	$\lambda_{10, \text{tr}} \leq 0.05 \text{ W} / \text{m} \cdot \text{K}$
U-value: window construction depth 75 mm / 85 mm / 95 mm	DIN 4108-3	$U = 0.7 \text{ W} / (\text{m}^2 \cdot \text{K}) / 0.6 \text{ W} / (\text{m}^2 \cdot \text{K}) / 0.55 \text{ W} / (\text{m}^2 \cdot \text{K})$
Sound reduction		45 dB in 10 mm joint
sd-value gradient (from internal to external)	DIN EN ISO 12572	$\approx 40:1$ (internal ≥ 22 ; external ≤ 0.5)
ETA - 15/0407		CE mark since 2015
Shelf life		1 year, dry and in original packing
Storage temperature		$+1^\circ\text{C}$ to $+20^\circ\text{C}$

Tape width / area of application	Width of U-recess	Area of application sealing level*	
		MF1	MF2
75/6 – 20mm	58 – 74mm		
85/6 – 20mm	68 – 84mm	6 – 20mm	6 – 27mm
95/6 – 20mm	78 – 94mm		
75/8 – 33mm	58 – 74mm		
85/8 – 33mm	68 – 84mm	8 – 33mm	8 – 43mm
95/8 – 33mm	78 – 94mm		

Alternative dimensions available on request.

* Movement of the components and temporary changes of length of the existing joints should be taken into account when determining the right tape size. Installation depths of the U-recess beyond these areas of application can be reduced using suitable insulation materials.



Installation example: ISO-BLOCO RENO

SERVICE

- standard delivery ex stock
- commercial and technical consultation

PACKAGING

pre-compressed rolls

ACCESSORIES

ISO-TOP FLEX-ADHESIVE PA and ISO-TOP FLEX-ADHESIVE XP

ISO-BLOCO MULTI-FUNCTIONAL TAPE

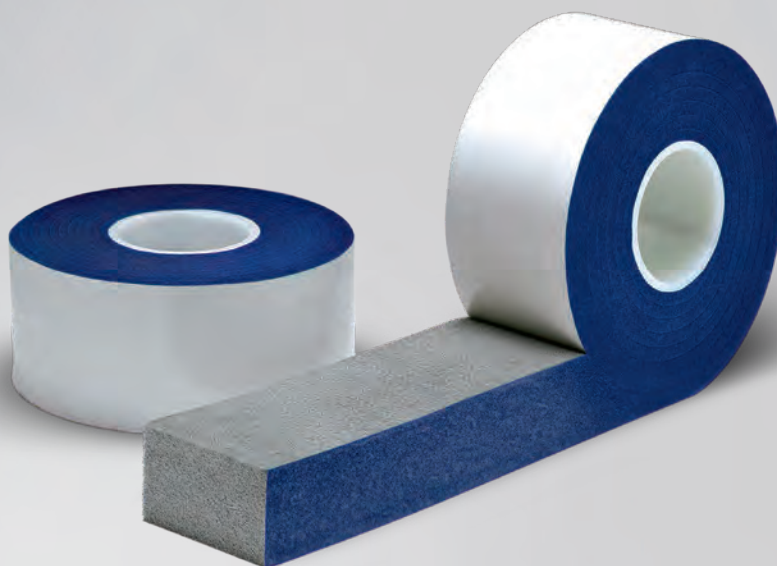

PRODUCT DESCRIPTION

The ISO-BLOCO MULTI-FUNCTIONAL TAPE is a special joint sealing strip with outstanding functionality that can be used for a wide range of applications. It is used to seal connection joints of windows and doors against drafts and driving rain. At the same time it also provides thermal and acoustic properties throughout the joint.

The ISO-BLOCO MULTI-FUNCTIONAL TAPE is permeable to vapour diffusion according to the RAL principles, this guarantees that the joint will dry out completely.

APPLICATION

The ISO-BLOCO MULTI-FUNCTIONAL TAPE is an “all-in-one tape” which combines all the requirements of Building Energy Act GEG (EnEV was valid 31.10.20) and the RAL “installation guide” in one product. It is therefore especially suitable for the safe, as in reliable, straightforward and time saving sealing of window and door connections.

PACKAGING

pre-compressed rolls with self-adhesion on one side (to aid installation)

PRODUCT ADVANTAGES

- 3-level seal with just one product
- sealing a wide range of joints with a minimum of tape dimensions
- easy one step application for a reliable seal
- significant cost advantage through time saving installation during fitting
- can be installed in adverse weather conditions
- complies with the requirements of the Building Energy Act (EnEV was valid 31.10.20) and the recommendations of the RAL “installation guide”
- weather-proof according to DIN 18542 BG 1
- 10 Year Function Warranty*

* On the conditions of the manufacturer (available on request).



ISO-BLOCO WIN2WALL

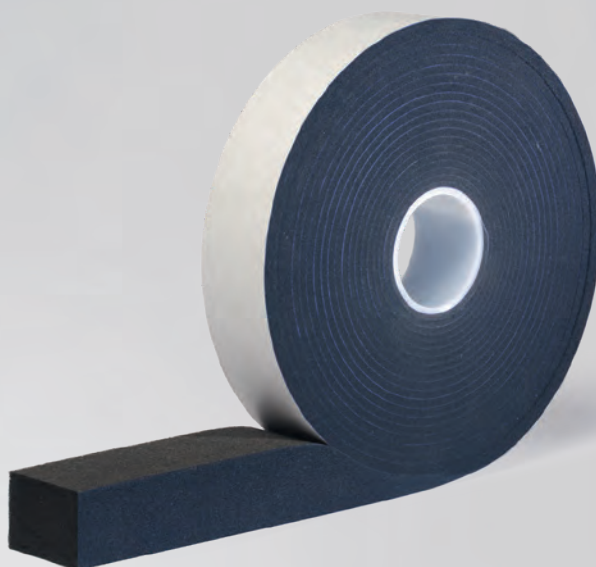

PRODUCT DESCRIPTION

The ISO-BLOCO WIN2WALL sealing tape is a special energy saving joint sealing product with outstanding functionality that can be used in a wide range of applications. Primarily designed as a multi-level seal for the perimeter joint between windows, doors and walls. It provides an exceptionally thermally efficient weather and air tight seal, while accommodating the constant movement between components.

The ISO-BLOCO WIN2WALL is permeable to vapour diffusion according to the RAL principles of 3-level sealing and is more air tight on the inside than the out. This guarantees that the joint will dry out completely.

APPLICATION

The ISO-BLOCO WIN2WALL is one of our range of multi-functional tapes and is specifically designed for the UK market to enhance the installation of A, A+ and A++ energy rated windows. The thermal efficiency of the tape often gives the joint between window and wall a better U-value than the window itself, saving the end user money in reduced energy bills. It is especially suitable for the secure, reliable, straightforward and time saving sealing of window and door connections. It can eliminate the need for external access during /after installation and can be applied in all weather conditions. It is a standalone product that needs no additional capping or protection against both UV and /or driving rain.

PRODUCT ADVANTAGES

- 3-level seal with just one product
- energy saving thermal insulation of the joint
- high acoustic insulation between window and wall
- easy one step application for a reliable seal
- significant cost advantage through time saving installation during fitting
- can be installed in adverse weather conditions

SERVICE

- standard sizes available from stock
- competent experienced technical support available in the field and by phone

PACKAGING

pre-compressed rolls with self-adhesion on one side (to aid installation)

Technical data	Standard	Classification
Material description		impregnated PUR flexible foam
Base		fire-resistant polymeric dispersion
Colour		black, inside: blue
Air permeability coefficient	DIN EN 12114	$\alpha \leq 0.1 \text{ m}^3 / [\text{h} \cdot \text{m} \cdot (\text{daPa})^n]$
Impermeable to driving rain	DIN EN 1027	$\geq 600 \text{ Pa}$
Temperature stability range	DIN 18542	-30°C to +80°C
Classification according to	DIN 18542	BG 1 and BGR
UV light and weather stability	DIN 18542	requirements fulfilled
Compatibility with adjacent building materials	DIN 18542	requirements fulfilled
Dimension tolerance	DIN 7715 TP P3	requirements fulfilled
Building material class	DIN 4102	B1 (fire resistant)
Thermal conductivity	DIN EN 12667	$\lambda = 0.048 \text{ W/m} \cdot \text{K}$
Water vapour diffusion resistance μ	DIN EN ISO 12572	≤ 100
Steam pressure gradient		outside vapour permeable (opposite to coloured side)
U-value: window construction depth 40mm / 60mm	DIN 4108-3	$U = 1.20 \text{ W}/(\text{m}^2 \cdot \text{K}) / 0.75 \text{ W}/(\text{m}^2 \cdot \text{K})$
Shelf life		12 months, dry and in original packaging
Storage temperature		+1°C to +20°C

Tape width / area of application	Recommended joint width*	Carton (metres)	Thermally suitable for UK energy rated windows
40 / 2 – 8 mm	2 – 8 mm	120m	C, B and A rated
64 / 2 – 8 mm		90m	A+ and A++ rated

Alternative dimensions available on request.

* Movement of the components and temporary changes of length of the existing joints should be taken into account when determining the right strip size.



Installation example: ISO-BLOCO WIN2WALL

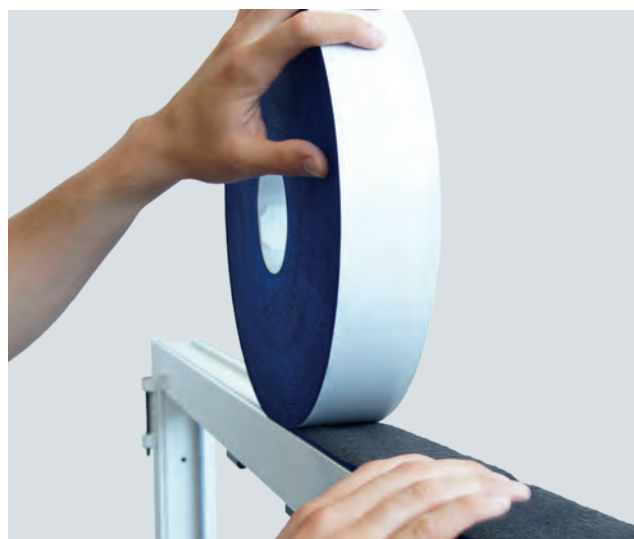

Installation example: ISO-BLOCO WIN2WALL

IN FRONT OF WALL INSTALLATION SYSTEM ISO-TOP WINFRAMER „TYPE 1“

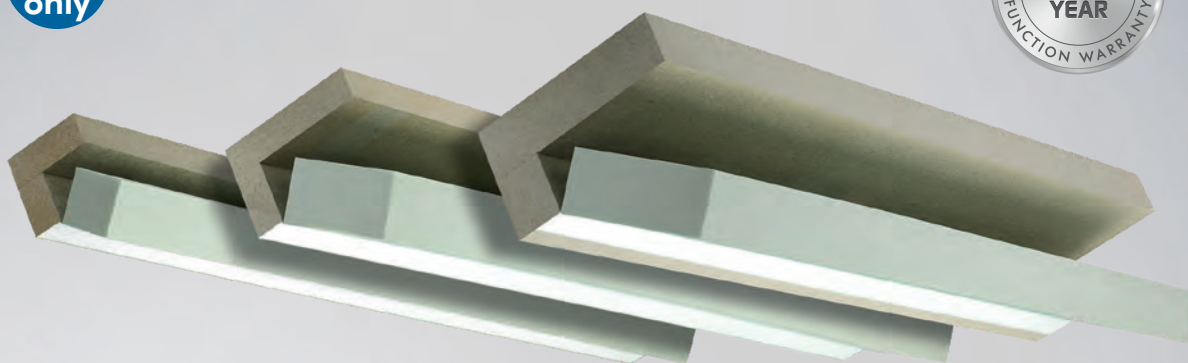

PRODUCT DESCRIPTION

IN FRONT OF WALL INSTALLATION SYSTEM ISO-TOP WINFRAMER „TYPE 1“ makes it possible to position and fit windows within the insulation plane. The ISO-TOP WINFRAMER „TYPE 1“ comprises a thermally insulating and load-bearing system angle made of PURATHERM which is equipped with a high thermally insulating core. The thermally insulating core is connected to the system angle by means of a hinged mechanism. The advantage of this is that the insulating core can simply be moved out of the way while mechanically securing with screws. System boards are also available for applications where the window is only partially overhanging. In addition, the system brackets can be combined with the system boards to achieve greater overhangs. The system brackets and system boards are prefabricated in many different formats and can be cut to length on site using a mitre saw. Attachment to the masonry is by means of ISO-TOP FLEX-ADHESIVE WF and additional attachment using screws (see ISO-TOP WF FIXINGS).

APPLICATION

The system brackets and boards are suitable for bearing the loads of windows and doors and provide an optimum base for sealing window connection joints. The window and door elements are attached directly and mechanically to the supporting frame system. This is possible with both classic screw fixings through the window frame, or with extended metal lug fixings. The in front of wall installation system is then covered by either an External Wall

PRODUCT ADVANTAGES

- windows can be fitted into the thermal insulation level
- extensive individual tests by testing institutes**
- integrated thermal insulation core (system brackets)
- simple adjustment of length using standard mitre saws
- reduction of structure-related thermal bridges
- simple installation thanks to the convenient insertion system
- complies with the requirements of the Building Energy Act and the recommendations of the RAL "installation guide"
- certified Passive House component
- fire rated for 30 minutes according to BS EN 13501-2
- 10 Year Function Warranty*

* On the conditions of the manufacturer (available on request).

** In front of wall installation systems are currently not subject to any regulation by the DIBt. Approvals such as aBG or abZ must therefore be covered by individual tests. Details on approval as in front of wall installation system for building projects must be obtained individually from the responsible planning office.

Insulation system, or rain screen facade of whatever type is designed. The integrated thermal core of the system together with the solid installation frame guarantee an optimum Ψ -value (Psi).



SYSTEM COMPONENTS

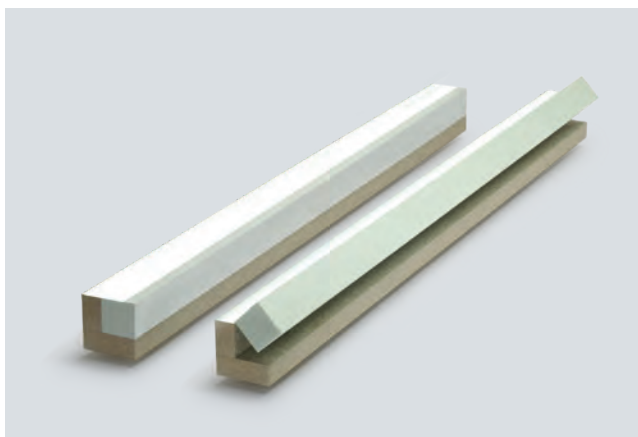

ISO-TOP WINFRAMER SYSTEM BRACKET „TYPE 1“ 80/80, 90/80

The system bracket 80/80 resp. 90/80 is available for typical in front of wall installations. The ISO-TOP WINFRAMER SYSTEM BRACKETS „TYPE 1“ 80/80 resp. 90/80 are suitable whenever windows are fitted in the direct transition area between the wall and the External Wall Installation system. With its 80 mm or 90 mm width dimension it has been adapted to standard window systems. The fixing areas guarantee a straightforward, fast and reliable window installation.

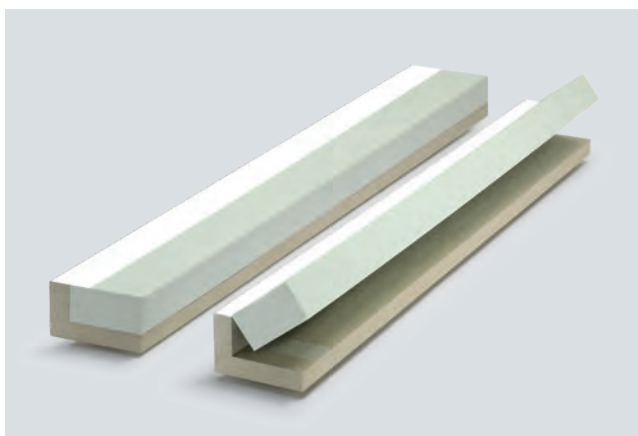

ISO-TOP WINFRAMER SYSTEM BRACKET „TYPE 1“ 140/90

ISO-TOP WINFRAMER SYSTEM BRACKET „TYPE 1“ 140/90 is designed for deeper window profiles, or for use with combination products such as roller shutters etc. These additional products can be fitted within the depth of the ISO-TOP WINFRAMER SYSTEM BRACKET „TYPE 1“ so the perimeter seals are all at the same plane. The sealing can be done within the system bracket level, as planned.

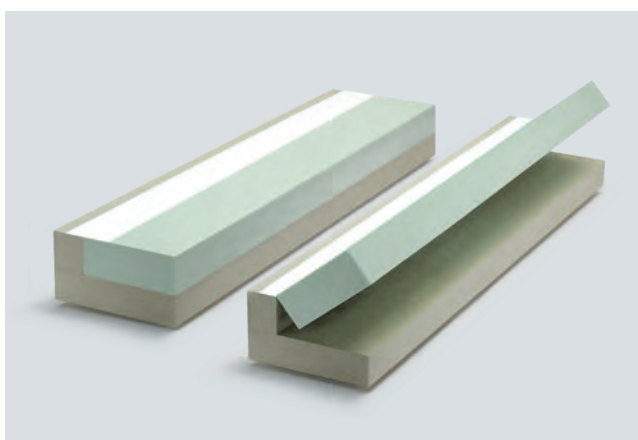

ISO-TOP WINFRAMER SYSTEM BRACKET „TYPE 1“ 160/110, 180/110, 200/110

The ISO-TOP WINFRAMER SYSTEM BRACKETS „TYPE 1“ with a maximum projection of 200 mm can be used for cavity wall structures with brick facades. This system component is available for especially large projections of 160, 180 and 200 mm. Thermal insulating layers are becoming thicker not only where External Wall Insulation (EWI) systems are used, but also on buildings with assorted rainscreen facades, such as brick, etc. As with the EWI finish the ISO-TOP WINFRAMER SYSTEM BRACKET „TYPE 1“ should be attached to the front of the load bearing wall.



IN FRONT OF WALL INSTALLATION SYSTEM ISO-TOP WINFRAMER „TYPE 1“

SYSTEM COMPONENTS

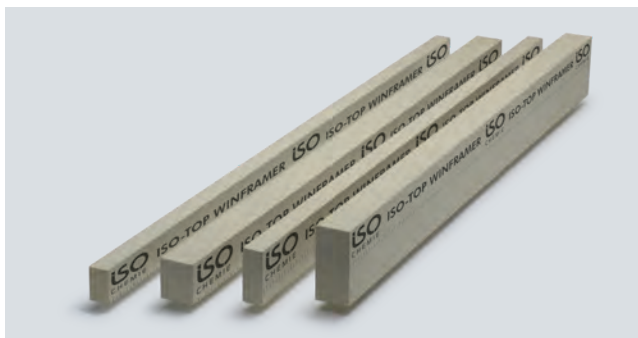

ISO-TOP WINFRAMER SYSTEM BOARDS

The system boards in the IN FRONT OF WALL INSTALLATION SYSTEM ISO-TOP WINFRAMER „TYPE 1“ offer a range of different application options. ISO-TOP WINFRAMER SYSTEM BOARDS are also available for applications where the window is only partially overhanging with some External Wall Insulation systems. In addition, the system brackets can be combined with the system boards to achieve greater overhang.



SYSTEM ADHESIVE ISO-TOP FLEX-ADHESIVE WF

ISO-TOP FLEX-ADHESIVE WF is a high-quality, neutral cure, single-component, permanently flexible adhesive on a hybrid-polymer basis. It was developed especially for gluing the IN FRONT OF WALL INSTALLATION SYSTEMS ISO-TOP WINFRAMER and makes tension-free structural bonding of the system possible. ISO-TOP FLEX-ADHESIVE WF is also used for sealing and bonding corner connections and can be used on damp surfaces. Refer to the ISO-TOP FLEX-ADHESIVE WF product data sheet for further information.



PROCESSING

The IN FRONT OF WALL INSTALLATION SYSTEM ISO-TOP WINFRAMER „TYPE 1“ is sealed to the masonry using ISO-TOP FLEX-ADHESIVE WF. This can also be used for optimum sealing of the material joints and corners. The use of further ISO³-WINDOW SEALING SYSTEM products is recommended for seals between the window and the in front of wall installation system. More detailed processing information can be found in the installation instructions.

ISO-TOP WINFRAMER INSERTION SYSTEM

ISO-TOP WINFRAMER SYSTEM BRACKETS „TYPE 1“ are equipped with a convenient insertion system as standard. The tongue and groove design allows the ends of system brackets to be fitted together easily and quickly. System joints are bonded using ISO-TOP FLEX-ADHESIVE WF. The practical insertion system makes installation significantly easier on long rows of windows, allowing work to be mastered professionally by a single person. In addition, the insertion system makes levelling of the system brackets to be installed easier, enhancing the attractive appearance and technical installation quality.

IN FRONT OF WALL INSTALLATION SYSTEM ISO-TOP WINFRAMER „TYPE 1“ PREFAB

PRODUCT DESCRIPTION

ISO-TOP WINFRAMER „TYPE 1“ PREFAB is the project-related version of the „TYPE 1“ in front of wall installation system prefabricated at the factory to optimise time and costs. The main advantages are its configurable delivery lengths and projection dimensions as well as the option of prefabricating complete supporting frames. In addition, the „TYPE 1“ PREFAB has all the technical advantages of the tried-and-trusted „TYPE 1“.

The system brackets of the IN FRONT OF WALL INSTALLATION SYSTEM ISO-TOP WINFRAMER „TYPE 1“ PREFAB can be produced individually according to the object-specific lengths required. Delivery in tailor-made project lengths makes it possible to prefabricate complete supporting frames for different window openings in your factory. This means corresponding window frames can be pre-assembled with a RAL-compliant sealing system in the prefabricated supporting frame of the IN FRONT OF WALL INSTALLATION SYSTEM ISO-TOP WINFRAMER „TYPE 1“ PREFAB.

There are several advantages to prefabrication. Workflows in your factory can be optimised in terms of time and costs under controlled conditions. This saves money and makes costing calculations more reliable. Assembly in the factory – no matter the weather conditions outside – prevents any problematic assembly delays. Furthermore, assembly times on the construction site can be significantly reduced.

APPLICATION

The IN FRONT OF WALL INSTALLATION SYSTEM ISO-TOP WINFRAMER „TYPE 1“ PREFAB can be used for the complete in front of wall installation with a window element as a closed frame system. The four individual parts of the frame are delivered with a building-specific cut length of up to 2,400 mm and mechanically connected using specially developed ISO-TOP WINFRAMER CORNER CONSOLES made of metal. Optionally available ISO-TOP WINFRAMER CRANE EYELETS allow ready-to-assemble facade elements comprising a supporting frame element and window frame to be transported to the installation location and lifted to the respective instal-

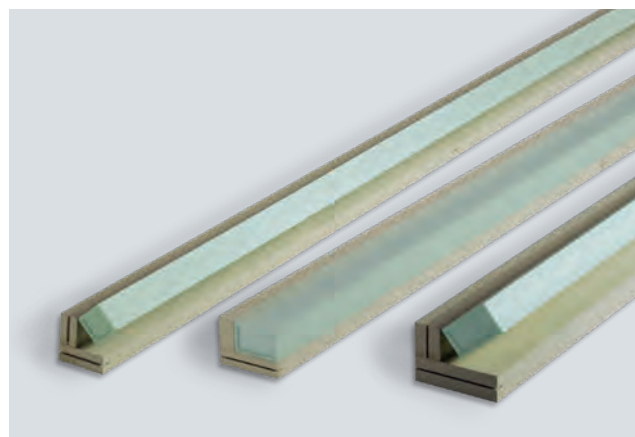

lation spot by crane. The „TYPE 1“ PREFAB is glued to the outside masonry all the way round the window opening first using the system adhesive ISO-TOP FLEX-ADHESIVE WF and then screwed in place. The requirement of using ETA-tested attachment systems to match the outside masonry and the edge projection specifications applies here too. Subsequently, a segment of the movable insulating core is partially broken out via a pre-designed break-off line to positively fit the corner consoles and then fixed using a few adhesive points. The insulating core guarantees reliable integration in the EWIS by reducing thermal bridges.

IN FRONT OF WALL INSTALLATION SYSTEM ISO-TOP WINFRAMER „TYPE 1“ PREFAB

SYSTEM COMPONENTS

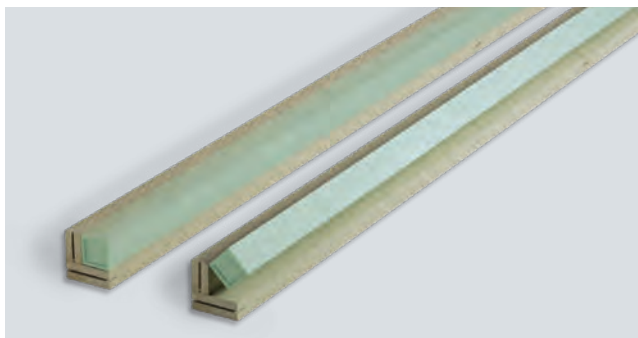

ISO-TOP WINFRAMER SYSTEM BRACKETS „TYPE 1“ PREFAB 80/80 - 200/110

We have ISO-TOP WINFRAMER SYSTEM BRACKETS „TYPE 1“ PREFAB in the dimensions 80/80, 90/80, 140/90, 160/110, 180/110 and 200/110 in the range for typical in front of wall installation applications. Since most building projects have differently dimensioned window openings, we provide the system brackets for „TYPE 1“ PREFAB in individual cut lengths up to 2,400 mm. This avoids residue on site and makes expensive adaptation unnecessary. The ISO-TOP WINFRAMER CORNER CONSOLES screwed into the rebate area are covered with the ISO-TOP WINFRAMER INSULATING CORE „TYPE 1“ PREFAB to reduce structural thermal bridges.

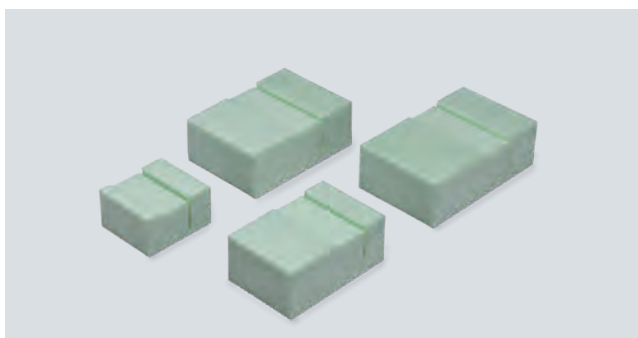
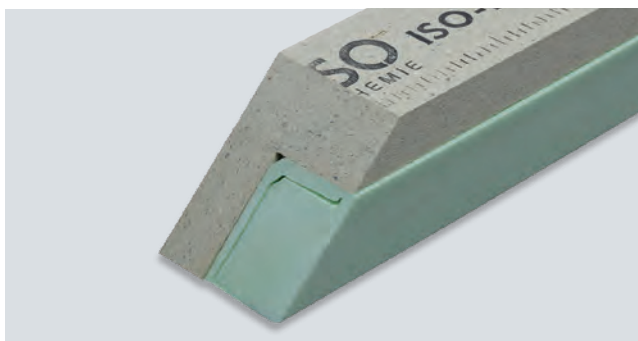

ISO-TOP WINFRAMER INSULATING BLOCKS

The corners of the 4-sided frame system can be mitre-cut or butt-jointed. The prefabricated ISO-TOP WINFRAMER INSULATING BLOCKS can be used for thermal insulation at butt-jointed corners. They are available as an option for the standard dimensions.

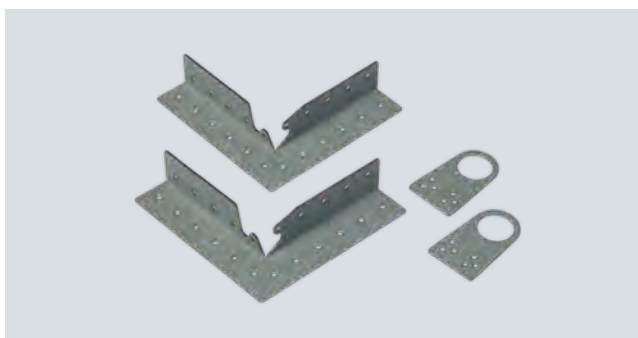

ISO-TOP WINFRAMER CORNER CONSOLES & CRANE EYELETS

We supply specially developed corner consoles made of metal for the connection of the four ISO-TOP WINFRAMER SYSTEM BRACKETS „TYPE 1“ PREFAB to a prefabricated supporting frame. The ISO-TOP WINFRAMER CORNER CONSOLES are screwed in the rebate area and then covered with the movable insulating core. The optional ISO-TOP WINFRAMER CRANE EYELETS allow the ready-to-assemble facade element made up of a supporting frame and window frame to be transported by crane to the respective installation spot.

Technical data:	Standard	Classification		
ISO-TOP WINFRAMER SYSTEM BRACKETS „TYPE 1“, „TYPE 1“ PREFAB and SYSTEM BOARDS:				
Material description		PURATHERM (PUR composite)		
Colour		beige		
Building material class	BS EN 13501-1	E		
Airtightness	DIN EN 12114	$\alpha \leq 0,1 \text{ m}^3 / [\text{h} \cdot \text{m} \cdot (\text{daPa})^{2/3}]$		
Impermeable to driving rain	DIN EN 1027	$\geq 1,050 \text{ Pa}$		
UV stability		6 months direct weathering during the construction phase		
European technical assessment (PURATHERM)	EAD 04019-00-1201	ETA-19/0199		
Fire resistance period	BS EN 13501-2	EI 15 and E 30		
Thermal conductivity	BS EN 12667	$\lambda = 0.096 \text{ W} / (\text{m} \cdot \text{K})$		
Average U-value: finish 80/80		$0.51 \text{ W} / (\text{m}^2 \cdot \text{K})$		
Average U-value: finish 140/90		$0.27 \text{ W} / (\text{m}^2 \cdot \text{K})$		
Average U-value: finish 200/110		$0.20 \text{ W} / (\text{m}^2 \cdot \text{K})$		
Sound insulation / evaluated joint sound reduction index	EN ISO 10140-1 / -2	$R_{s,w} (C; C_{tr}) = 53 (0; -1) \text{ dB}$		
Burglar resistant	DIN EN 1627	resistance class RC2 and RC3		
Temperature resistance		-50°C to $+100^\circ\text{C}$		
Ageing resistance		resistant to rotting, non-rotting		
Humidity resistance		high humidity resistance / resistant to mould and termites		
Dimensional stability		high dimensional stability even with natural weathering		
Load transfer		200 kg/m depending on wall substrate and projection		
Dimension tolerance	DIN 7715 T5 P3	requirements fulfilled		
Shelf life (system brackets, system boards and insulating core)		24 months		
ISO-TOP WINFRAMER INSULATING CORE „TYPE 1“, „TYPE 1“ PREFAB and INSULATING BLOCKS:				
Material description		XPS insulating core		
Building material class	DIN 4102	E		
Thermal conductivity	BS EN 12667	$\lambda = 0.034 \text{ W} / (\text{m} \cdot \text{K})$		
Resistance		usual construction materials, except solvents		
Dimension tolerance	DIN 7715 T5 P3	requirements fulfilled		
System components	Length	Width	Height	Load transfer
ISO-TOP WINFRAMER SYSTEM BRACKETS „TYPE 1“ 80/80	1,200 mm	80 mm	80 mm	200 kg/m
ISO-TOP WINFRAMER SYSTEM BRACKETS „TYPE 1“ 90/80	1,200 mm	90 mm	80 mm	200 kg/m
ISO-TOP WINFRAMER SYSTEM BRACKETS „TYPE 1“ 140/90	1,200 mm	140 mm	90 mm	200 kg/m
ISO-TOP WINFRAMER SYSTEM BRACKETS „TYPE 1“ 160/110	1,200 mm	160 mm	110 mm	200 kg/m
ISO-TOP WINFRAMER SYSTEM BRACKETS „TYPE 1“ 180/110	1,200 mm	180 mm	110 mm	200 kg/m
ISO-TOP WINFRAMER SYSTEM BRACKETS „TYPE 1“ 200/110	1,200 mm	200 mm	110 mm	200 kg/m
ISO-TOP WINFRAMER SYSTEM BOARDS	width/height: 30/50; 30/60; 30/80; 30/90; 50/60; 50/80 and 50/110 mm; length: 1,200 mm			
ISO-TOP WINFRAMER SYSTEM BRACKETS „TYPE 1“ PREFAB 80/80	building-specific	80 mm	80 mm	200 kg/m
ISO-TOP WINFRAMER SYSTEM BRACKETS „TYPE 1“ PREFAB 90/80	building-specific	90 mm	80 mm	200 kg/m
ISO-TOP WINFRAMER SYSTEM BRACKETS „TYPE 1“ PREFAB 140/90	building-specific	140 mm	90 mm	200 kg/m
ISO-TOP WINFRAMER SYSTEM BRACKETS „TYPE 1“ PREFAB 160/110	building-specific	160 mm	110 mm	200 kg/m
ISO-TOP WINFRAMER SYSTEM BRACKETS „TYPE 1“ PREFAB 180/110	building-specific	180 mm	110 mm	200 kg/m
ISO-TOP WINFRAMER SYSTEM BRACKETS „TYPE 1“ PREFAB 200/110	building-specific	200 mm	110 mm	200 kg/m
ISO-TOP WINFRAMER INSULATING BLOCKS	width/height: 80/80; 90/80; 140/90; 160/110; 180/110; and 200/110 mm; length: 50 mm (80/80, 90/80) and 60 mm (140/90, 160/110, 180/110 and 200/110)			
ISO-TOP FLEX-ADHESIVE WF	for fixing on the wall and sealing the system joints			
ISO-TOP WF FIXINGS	for mechanical mounting on the wall			

IN FRONT OF WALL INSTALLATION SYSTEM ISO-TOP WINFRAMER „TYPE 1“ E30



PRODUCT DESCRIPTION

The IN FRONT OF WALL INSTALLATION SYSTEM ISO-TOP WINFRAMER „TYPE 1“ E30 makes it possible to position and fit windows within the insulation plane. It comprises a thermally insulating and load-bearing system angle made of PURATHERM E30. The intumescent effect of the new PURATHERM E30 material makes the ISO-TOP WINFRAMER „TYPE 1“ E30 especially suitable for use in fire protection façades. ISO-TOP WINFRAMER SYSTEM BOARDS E30 are also available for applications where the window is only partially overhanging. These can be combined with the system brackets to achieve greater overhangs. ISO-TOP WINFRAMER SYSTEM BRACKETS „TYPE 1“ E30 AND SYSTEM BOARDS E30 are prefabricated in many different formats and can be cut to length on site using a mitre saw. Attached to the masonry is by means of ISO-TOP FLEX-ADHESIVE WF and additional mechanical fixings using screws (see ISO-TOP WF FIXINGS).

APPLICATION

The system brackets and system boards are suitable for use where special fire protection requirements are in place for bearing the loads of windows, balcony and patio doors and they provide an optimum base for sealing window connection joints. The window and door elements are attached directly and mechanically to the supporting frame system. This is possible both with classic screw fixings through the window frame, or

PRODUCT ADVANTAGES

- windows can be fitted into the thermal insulation level
- extensive individual tests by testing institutes**
- E30 according to EN 1366-4
- with expansion effect when heated
- simple adjustment of length using standard mitre saws
- reduction of structure-related thermal bridges
- simple installation thanks to the convenient insertion system
- complies with the requirements of the Building Energy Act and the recommendations of the RAL "installation guide"
- can be combined with the system products of the ISO³-WINDOW SEALING SYSTEM
- 10 Year Function Warranty*

* On the conditions of the manufacturer (available on request).

** In front of wall installation systems are currently not subject to any regulation by the DIBt. Approvals such as aBG or abZ must therefore be covered by individual tests. Details on approval as in front of wall installation system for building projects must be obtained individually from the responsible planning office.

with extended metal lug fixings. The in front of wall installation system is then covered by an External Wall Insulation system made of mineral wool or EPS-F.



Technical data	Standard	Classification
ISO-TOP WINFRAMER SYSTEM BRACKETS „TYPE 1“ E30 and SYSTEM BOARDS E30:		
Material description		PURATHERM E30 (intumescent PUR composite)
Colour		beige
Building material class	DIN EN 13501-1	E / C-s3, d0 (fire resistant)
UV stability		6 months direct weathering during the construction phase
European technical assessment (PURATHERM E30)	EAD 04019-00-1201	ETA-19/0199
Fire resistance period	DIN EN 13501-2	EI 15 and E 30
Thermal conductivity	DIN EN 12667	$\lambda = 0.096 \text{ W}/(\text{m} \cdot \text{K})$
Sound insulation / evaluated joint sound reduction index	EN ISO 10140-1 / 10140-2	$R_{s,w} (C; C_{tr}) = 53 (0; -1) \text{ dB}$
Temperature resistance		-50°C to +100°C
Ageing resistance		resistant to rotting, non-rotting
Humidity resistance		high humidity resistance / resistant to mould and termites
Dimensional stability		high dimensional stability even with natural weathering
Load transfer		200kg/m depending on wall substrate and projection
Dimensional tolerance	DIN 7715 T5 P3	requirements fulfilled
Storage time		24 months

System components	Length	Width	Height	Load transfer
ISO-TOP WINFRAMER SYSTEM BRACKETS „TYPE 1“ E30 80/80	1,200 mm	80 mm	80 mm	200 kg / m
ISO-TOP WINFRAMER SYSTEM BRACKETS „TYPE 1“ E30 90/80	1,200 mm	90 mm	80 mm	200 kg / m
ISO-TOP WINFRAMER SYSTEM BRACKETS „TYPE 1“ E30 140/90	1,200 mm	140 mm	90 mm	200 kg / m
ISO-TOP WINFRAMER SYSTEM BRACKETS „TYPE 1“ E30 160/110	1,200 mm	160 mm	110 mm	200 kg / m
ISO-TOP WINFRAMER SYSTEM BRACKETS „TYPE 1“ E30 180/110	1,200 mm	180 mm	110 mm	200 kg / m
ISO-TOP WINFRAMER SYSTEM BRACKETS „TYPE 1“ E30 200/110	1,200 mm	200 mm	110 mm	200 kg / m
ISO-TOP WINFRAMER SYSTEM BOARDS E30	width/height: 30/50; 30/60; 30/80; 30/90; 50/60; 50/80 und 50/110 mm; length: 1,200 mm			
ISO-TOP FLEX-ADHESIVE WF	for fixing on the wall and sealing the system joints			
ISO-TOP WF FIXINGS	for mechanical mounting on the wall			

ISO-TOP CONSTRUCTION SHEETS WF3



PRODUCT DESCRIPTION

ISO-TOP CONSTRUCTION SHEETS WF3 made of high-density THERMAPOR offer the possibility of individual, constructive adaptation for assembly and sealing details on the IN FRONT OF WALL INSTALLATION SYSTEM ISO-TOP WINFRAMER. They can be cut to size and geometry, to individual requirements, on the construction site. They can be used both as adapter sheets in combination with the system profiles or individually as substructure profiles, liners and window sill moldings and in the fitting of blinds and shutters.

With a bending resistance of more than 650 kPa, the ISO-TOP CONSTRUCTION SHEETS WF3 offer a very high bearing capacity for windows or doors.

PRODUCT ADVANTAGES

- windows can be fitted into the thermal insulation level
- optimum integration in EWI systems
- optimisation of the Ψ -value thanks to highly thermal properties
- simple adjustment of length using standard mitre saws
- ideal basis for 3-level-sealing with multi-functional joint sealing strips
- excellent for energy-related building renovation
- complies with the requirements of the Building Energy Act (EnEV was valid 31.10.20) and the recommendations of the RAL "installation guide"
- can be combined with the system products of the ISO³-WINDOW SEALING SYSTEM
- certified Passive House component
- 10 Year Function Warranty*

* On the conditions of the manufacturer (available on request).



Technical data	Standard	Classification
Material description		THERMAPOR (EPS-F / flame-retardant)
Colour		silver grey
National test certificate for a construction product		P-23-001616-PRO2-ift
Building material class	DIN 4102-1	B2 (normal flammability)
Fire behaviour	DIN EN 13501-1	E
Airtightness	DIN EN 12114	$\alpha \leq 0,1 \text{ m}^3 / [\text{h} \cdot \text{m} \cdot (\text{daPa})^{2/3}]$
Impermeable to driving rain	DIN EN 1027	$\geq 1,200 \text{ Pa}$
Bulk density		$150 \text{ kg/m}^3 \pm 10\%$
Flame retardant		HBCD-free flame retardant
UV stability		6 months direct weathering during the construction phase
Compatibility with adjacent building materials	internal	requirements fulfilled
Compatibility with salt water		resistant
Compatibility with hydrochloric acid (10 %)		resistant
Compatibility with caustic soda (10 %)		resistant
Air permeability coefficient	DIN EN 12114	$\alpha = 0.00 \text{ m}^3 / [\text{h} \cdot \text{m} \cdot (\text{daPa})^n]$
Thermal conductivity	DIN EN 12667	$\lambda = 0.040 \text{ W} / (\text{m} \cdot \text{K})$
Form stability under thermal load		-40°C to +85°C
Temperature resistance	ISO 75-1	long-term +85 °C
Ageing resistance		resistant to rotting, non-rotting
Compressive strength at 2 %	DIN EN 826	1,194 N/mm ²
Compressive strength at 10 %		1,793 N/mm ²
Bending resistance	DIN EN 12089	$\geq 650 \text{ kPa}$
Shearing stress	DIN EN ISO 14130	$X = 0.217 \text{ N/mm}^2$
Creep characteristics at 20 % and 60 %		$E_m = 0.68 \text{ 0/00 up to } 5.2 \text{ 0/00}$
Water absorption (28 days storage)	DIN 12087	$\leq 1.5 \text{ Vol. \%}$
Water vapour diffusion resistance μ	DIN EN ISO 12572	< 500
Waste code		170604 170904
Load transfer		200 kg/m depending on wall substrate and projection
Dimension tolerance	DIN 7715 T5 P3	requirements fulfilled
Shelf life		24 months

System components	Length	Width	Height	Load transfer
ISO-TOP CONSTRUCTION SHEETS WF3 20		800 mm	20 mm	> 200 kg/m
ISO-TOP CONSTRUCTION SHEETS WF3 30		800 mm	30 mm	> 200 kg/m
ISO-TOP CONSTRUCTION SHEETS WF3 40		800 mm	40 mm	> 200 kg/m
ISO-TOP CONSTRUCTION SHEETS WF3 50	1.200 mm	800 mm	50 mm	> 200 kg/m
ISO-TOP CONSTRUCTION SHEETS WF3 60	and	800 mm	60 mm	> 200 kg/m
ISO-TOP CONSTRUCTION SHEETS WF3 70	2.400 mm	800 mm	70 mm	> 200 kg/m
ISO-TOP CONSTRUCTION SHEETS WF3 80		800 mm	80 mm	> 200 kg/m
ISO-TOP CONSTRUCTION SHEETS WF3 90		800 mm	90 mm	> 200 kg/m
ISO-TOP CONSTRUCTION SHEETS WF3 100		800 mm	100 mm	> 200 kg/m

Individual measures on request.

ISO-TOP WF FIXINGS



PRODUCT DESCRIPTION

High-quality screws and brackets are used for additional mechanical fixing of IN FRONT OF WALL INSTALLATION SYSTEMS ISO-TOP WINFRAMER. Window and door frames need to be mechanically fixed to the supporting frame system for in front of wall installation. The supporting frame system in turn also has to be screwed to the wall. The screws are specifically matched to the in front of wall installation system to guarantee quick and simple fitting.

APPLICATION

Once the supporting frame system has been bonded along its length to the relevant substrate (such as concrete, sand lime stone, brick, aircrete or wood) using ISO-TOP FLEX-ADHESIVE WF, it is then also fixed mechanically with the window screws described in this data sheet.

Additional fixing as described in the ETB guideline may also be needed for floor-level components. The IN FRONT OF WALL INSTALLATION SYSTEMS ISO-TOP WINFRAMER provide a number of different fixing methods for this purpose.





ISO-TOP WINFRAMER ALUMINIUM CONSOLES can be used at the installation stage as the basis for fixing in the system profile as described in the ETB guideline. The ISO-TOP ETB TIE PLATE EL and ISO-TOP JUSTA ETB ANCHOR BA can be used to create an ETB-compliant fixing on the inside of the window reveal either during or after installation. So the right fixing components are available for every application.

PRODUCT ADVANTAGES

- designed and approved for fixing in IN FRONT OF WALL INSTALLATION SYSTEMS ISO-TOP WINFRAMER
- approved for use on standard building substrates
- screw head shape designed specifically for high-density PUR and EPS systems

The ISO-TOP WF SCREWS were specially designed for the IN FRONT OF WALL INSTALLATION SYSTEM ISO-TOP WINFRAMER and can be used both to fix the window or door frame in the supporting frame system and for fixing to standard building substrates. The following table sets out the various screw type and lengths.

The installation instructions of ISO-TOP WINFRAMER provide information on using and fitting the ISO-TOP WF FIXINGS.

Component	Description	Size	Special features	Fixing
ISO-TOP WINFRAMER ALUMINIUM CONSOLES 	For inserting into the console slots of the „TYPE 3“ and in the fold area of the „TYPE 1“	98x50 mm; Thickness: 4 mm; for all overhangs of the „TYPE 1“ and „TYPE 3“	Easy to integrate during installation and can be subsequently fixed to existing attachment points as per the ETB guideline	ETB-compliant
ISO-TOP ETB TIE PLATE EL 	For simple fitting or retrofitting of fixings as per the ETB guideline	200 x 2.5 mm and 250 x 2.5 mm	Can be subsequently fixed to existing attachment points as per the ETB guideline	ETB-compliant
ISO-TOP JUSTA ETB ANCHOR BA 	For simple levelling and aligning of components as per the ETB guideline	140 x 50 mm and 250 x 50 mm; Screw length: 50 mm	Adjustment, load transfer and functional aligning using adjusting screws	ETB-compliant
ISO-TOP JUSTA TT BEARER PLATE 	For load transfer and lateral fixing of components	Diameter: 38 mm; Screw length: 50 mm	Adjustment, load transfer and functional aligning using adjusting screws	-
ISO-TOP ADJUSTING TOOL 	adjustment tool for JUSTA ETB ANCHOR BA and JUSTA TT BEARER PLATE	Length: 185 mm	Mechanical ratcheting function for adjusting the window position when installed	-

ISO-TOP WF SCREWS

Strength class		FKL C20/25	FKL 12	FKL T10	FKL PP2	FKL ≥ C24
Wall material	Window in the frame	Concrete	Sand lime stone	Brick / Poroton	Aircrete	Wood
ISO-TOP WINFRAMER „TYPE 1“, „TYPE 1“ PREFAB, „TYPE 1“ E30 and „TYPE 2“						
80/80 to 140/90	FB-FK-T30 7.5x132	FB-SK-T30 7.5x82	FB-SK-T30 7.5x82	FB-SK-T30 7.5x252	FB-SK-T30 7.5x212	FB-SK-T30 7.5x82
150/110 to 200/110	FB-FK-T30 7.5x132	FB-SK-T30 7.5x102	FB-SK-T30 7.5x102	FB-SK-T30 7.5x300	FB-SK-T30 7.5x212	FB-SK-T30 7.5x102
ISO-TOP WINFRAMER „TYPE 3“						
70/80	FB-FK-T30 7.5x132	FB-FK-T30 7.5x112	FB-FK-T30 7.5x112	FB-FK-T30 7.5x350	FB-FK-T30 7.5x252	FB-FK-T30 7.5x112
80/80	FB-FK-T30 7.5x132	FB-FK-T30 7.5x122	FB-FK-T30 7.5x122	FB-FK-T30 7.5x350	FB-FK-T30 7.5x252	FB-FK-T30 7.5x122
100/80	FB-FK-T30 7.5x132	FB-FK-T30 7.5x152	FB-FK-T30 7.5x152	FB-FK-T30 7.5x350	FB-FK-T30 7.5x300	FB-FK-T30 7.5x152
120/80 and 140/80	FB-FK-T30 7.5x132	FB-FK-T30 7.5x182	FB-FK-T30 7.5x182	FB-FK-T30 7.5x400	FB-FK-T30 7.5x300	FB-FK-T30 7.5x182
160/80	FB-FK-T30 7.5x132	FB-FK-T30 7.5x212	FB-FK-T30 7.5x212	FB-FK-T30 7.5x400	FB-FK-T30 7.5x350	FB-FK-T30 7.5x212
180/80	FB-FK-T30 7.5x132	FB-FK-T30 7.5x252	FB-FK-T30 7.5x252	FB-FK-T30 7.5x400	FB-FK-T30 7.5x350	FB-FK-T30 7.5x252
200/80	FB-FK-T30 7.5x132	FB-FK-T30 7.5x252	FB-FK-T30 7.5x252	FB-FK-T30 7.5x400	FB-FK-T30 7.5x400	FB-FK-T30 7.5x252

FB = window screw, FK = flat-head, SK = countersunk, T30 = Torx size / bit size, FKL = strength class



Flat-head



Countersunk

ISO-CONNECT VARIO SD



PRODUCT DESCRIPTION

ISO-CONNECT VARIO SD is a humidity regulating special foil for sealing joints, which can also be used as an air tight seal internal, in accordance with the Building Energy Act GEG (EnEV was valid 31.10.20) on windows, doors and panels. Due to its special capabilities the sd-value of this universal foil adapts to the seasonal temperature gradient changes which occur within the joints from inside outwards and from outside inwards. It is a weather independent external and internal humidity transporter. The joints remain dry all year round and condensation damage can be avoided effectively, as well as providing the air tight requirements of the UK Building Regulations. ISO-CONNECT VARIO SD complies with the recommendations according to the RAL "installation guide" of the RAL quality assurance association for windows and doors.

APPLICATION

ISO-CONNECT VARIO SD is suitable for sealing of both internal and external window and door connecting joints. The foil can be used as an internal and at the same time an external sealant. The fleece covered special foil is equipped with a self-adhesive strip for a quick and proficient application on window framework. The foil can also be equipped with an additional butyl-adhesive strip for sealing to the wall. The FIX finish provides, with its practical mesh fixing and large self-adhesive strips, powerful surface adhesion and increased plaster adhesion. Fully self-adhesive finishes COMPLETE and COMPLETE DUO do not require any additional adhesion with ISO-TOP FLEX ADHESIVE.

PRODUCT ADVANTAGES

- high drying effect of joints through humidity regulating function
- only one product for internal and external sealing levels
- eliminates mix-ups thereby avoiding application mistakes
- simplicity for the purchasing department and saves storage space
- special fleece surface suitable for plastering and pasting over
- with self-adhesive and butyl-adhesive strip for single product application
- complies with the requirements of the Building Energy Act (EnEV was valid 31.10.20) and the recommendations of the RAL "installation guide"
- 10 Year Function Warranty*

* On the conditions of the manufacturer (available on request).

PACKAGING

rolls, roll length: 60 m (finish A), 30 m (finishes A-G, B, C, FIX, COMPLETE and COMPLETE DUO)



Technical data	Standard	Classification
Material description		synthetic fleece
Colour		white
Building material class	DIN EN 13501	E
Impermeable to driving rain	DIN EN 1027	≥ 1,050 Pa
Air permeability coefficient	DIN EN 1026	$\alpha \approx 0 \text{ m}^3 / [\text{h} \cdot \text{m} \cdot (\text{daPa})^0]$
UV stability		approx. 6 months
Compatibility with adjacent building materials	internal	requirements fulfilled
sd-value (vapour diffusion permeability)	DIN EN ISO 12572	sd-value depending on average humidity between 0.03 m (vapour permeable) and 15 m (vapour barrier)*
Temperature stability range	internal	approx. -40 °C to approx. +80 °C
Dimension tolerance	DIN 7715 T5 P3	requirements fulfilled
Handling temperature		finishes A, A-G, B, C: approx. +5 °C to approx. +45 °C finishes FIX, COMPLETE & COMPLETE DUO: approx. -10 °C to approx. +45 °C**
Shelf life		1 year, dry and in original packing
Storage temperature		+1 °C to +20 °C

* It is only possible to determine the variable sd-value with a dynamic calculation program (e.g. as indicated in the literature [10] in DIN 41083:2001-07). For the calculation according to the static method a fixed sd-value of 2.5m can be used.

** Finishes FIX, COMPLETE and COMPLETE DUO tested on frost-free surfaces (concrete blocks, cast concrete and bricks). Own tests should be done generally.

FINISHES

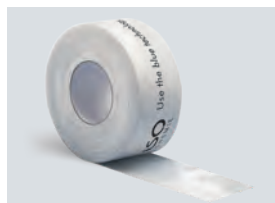

FINISH A

SK single side self-adhesive with 1 self-adhesive strip on the fleece side



FINISH FIX

2SK-GT double-sided self-adhesive, 2 self-adhesive strips (window mounting) on the fleece side and 1 special adhesive strip (wall mounting) on the smooth foil side + 10mm mesh



FINISH A-G

SK-GT single side self-adhesive with 1 self-adhesive strip on the fleece side + 100mm mesh



FINISH COMPLETE

full surface adhesive finish with a 2-way or 3-way split liner

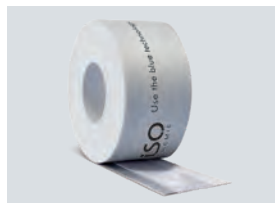

FINISH B

SK-BT Mono single side self-adhesive with 1 self-adhesive strip and 1 butyl-adhesive strip on the smooth foil side



FINISH COMPLETE DUO

full surface adhesive finish with a 2-way or 3-way split liner and 1 self-adhesive strip (window mounting)



FINISH C

SK-BT Duo alternating self-adhesive with 1 self-adhesive strip on the fleece side and 1 butyl-adhesive strip on the smooth foil side

DIMENSIONS

width finish A: 70, 90, 145, 180, 235, 290 mm

width finish A-G: 60, 90 mm

width finish B / C: 70, 90, 145 mm

width finish FIX: 100, 140 mm

width finishes COMPLETE / COMPLETE DUO: 70, 100, 140, 200, 290 mm

ISO-CONNECT VARIO XD

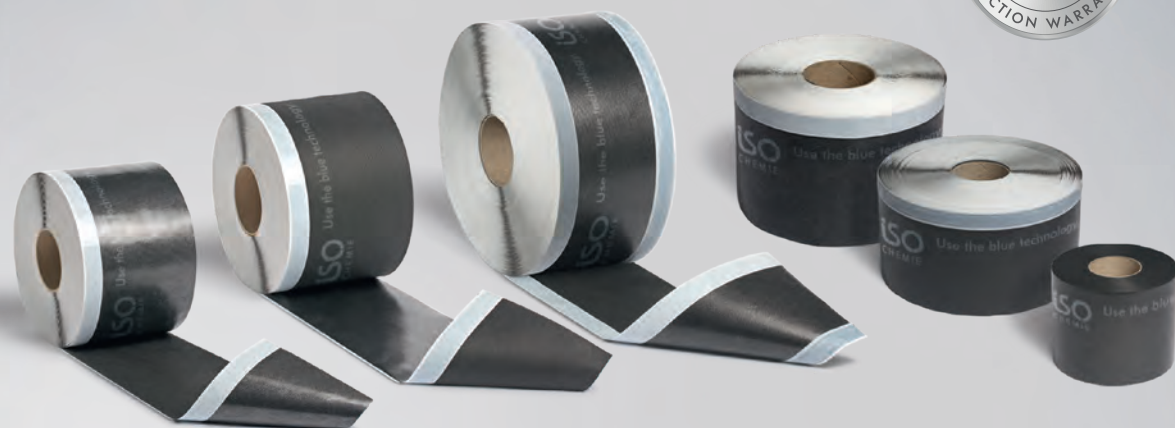

PRODUCT DESCRIPTION

ISO-CONNECT VARIO XD is a humidity variable special foil for the inner and outer sealing of windows and facade connecting joints. The foil reacts to the different seasonal temperature gradients by variably adapting its sd-value, thus achieving a high drying effect in the joint all year round. It complies with the requirements of GEG (Building Energy Act, EnEV was valid 31.10.20) concerning the airtightness of the building envelope and the recommendations of the RAL quality assurance association for windows and doors in the "installation guide".

APPLICATION

ISO-CONNECT VARIO XD is perfectly suited for the sealing of both internal and external window and door elements in metal, window and facade constructions. The fleece-covered special foil is available in different self-adhesive finishes for quick and proficient installation. The foil can be used under the window sill (eg. for External Wall Insulation systems) as the 2nd trough shaped sealing level.

FINISHES

- Finish A: without self-adhesive strip
- Finish B: SK foil; self-adhesive on one side using 1 acrylic strip on the smooth foil side
- Finish C: SK fleece; self-adhesive on one side using 1 acrylic strip on the textured fleece side
- Finish D: BT foil; self-adhesive on one side using 1 butyl strip on the smooth foil side

PRODUCT ADVANTAGES

- only one product for internal and external sealing (avoids application mistakes, makes purchasing and storage easier)
- high drying effect in the joint thanks to humidity-regulating functional mechanism (variable sd-value)
- resistant to driving rain up to more than 1,050 Pa
- high tear resistance
- up to 1 year UV light stability in any weather conditions
- special fleece surface, easy to plaster and glue over
- with self-adhesive strips for efficient application
- complies with the requirements of the Building Energy Act (EnEV was valid 31.10.20) and the recommendations of the RAL "installation guide"
- 10 Year Function Warranty*

* On the conditions of the manufacturer (available on request).

- Finish E: 2SK; self-adhesive on the same edge of both/alternating sides using 1 acrylic strip on the textured fleece side and 1 acrylic strip on the smooth foil side
- Finish F: 2SK-1BT Duo; self-adhesive on both/alternating sides using 1 acrylic strip on the textured fleece side and 1 acrylic strip, plus 1 butyl strip on the smooth foil side



Technical data	Standard	Classification
Material description		polymer fleece foil
Colour		black
Building material class	DIN EN 13501-1	E
Impermeable to driving rain	DIN EN 1027	≥ 1,050 Pa
sd-value (vapour diffusion permeability)	DIN EN ISO 12572	depending on the average air humidity, sd-value between approx. 1 and 12 m*
Air permeability coefficient	DIN EN 12114	$a \leq 0.1 \text{ m}^3 / [\text{h} \cdot \text{m} \cdot (\text{daPa})^{2/3}]$
UV stability (fleece side)		approx. 12 months
Temperature stability range		approx. -40°C to approx. +80°C
Handling temperature		approx. +5°C to approx. +45°C
Dimension tolerance	DIN 7715 T5 P3	requirements fulfilled
Shelf life		1 year, dry and in original packing

* The recording of the variable sd-value is only possible with a dynamic calculation program (e. g. in accordance with literature specification [10] in DIN 4108-3:2001-07). When calculation is done using a static method, a fixed sd-value of 2.5 m can be used.

PROCESSING

The bonding surfaces must be free of humidity, dust, stripping agents, oil, grease and other anti-adhesive substances. Pretreat porous and absorbent surfaces with primer. Bond the window connection foil without tension with sufficient slack for movement between the frame and the building reveal. Unless using finish F, we recommend ISO-TOP FLEX-ADHESIVE for this purpose (see product data sheet ISO-TOP FLEX-ADHESIVE for the correct selection to match your requirements). Apply enough adhesive to leave a caterpillar strip about 30 mm wide and at least 1 mm thick after the foil has been pressed in place.

With the butyl self-adhesive version, pretreat the surface with primer if necessary and then apply the butyl self-adhesive to the surface. Use a roller to carefully press the strip in place. On areas which are to be plastered over, a full surface bonding caterpillar strip should be applied. A foil surface of max. 20 mm should be left unglued to allow for potential movement. Corners and overlaps in the foil must be bonded using ISO-TOP FLEX-ADHESIVE. It must be noted that only the fleece-covered side can be plastered over. The window connection foil bonded to the outside of the building must always be covered. As the 2nd level sealing, under a window sill, lay it in a trough shape with side going up the reveal wall, paying particular attention to the corners (possibly by using preprepared corners). For detailed information about processing see the installation instructions.

DIMENSIONS

width: 70 – 600 mm (depending on the finish)

PACKAGING

rolls, roll length: 50 m

SELECT SPECIFIC VERSION ACCORDING TO INSTALLATION DETAILS

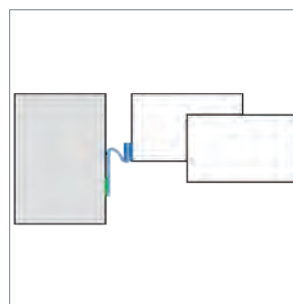

Finish F: 2SK-1 BT Duo

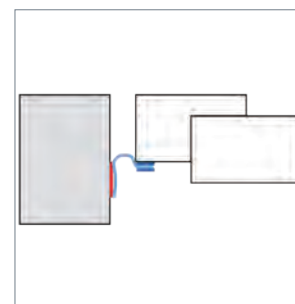

Finish E: 2SK and ISO-TOP FLEX-ADHESIVE



SK one-sided self-adhesive for bonding to frames



SK alternating self-adhesive for bonding to fram

ISO-CONNECT OUTSIDE EPDM

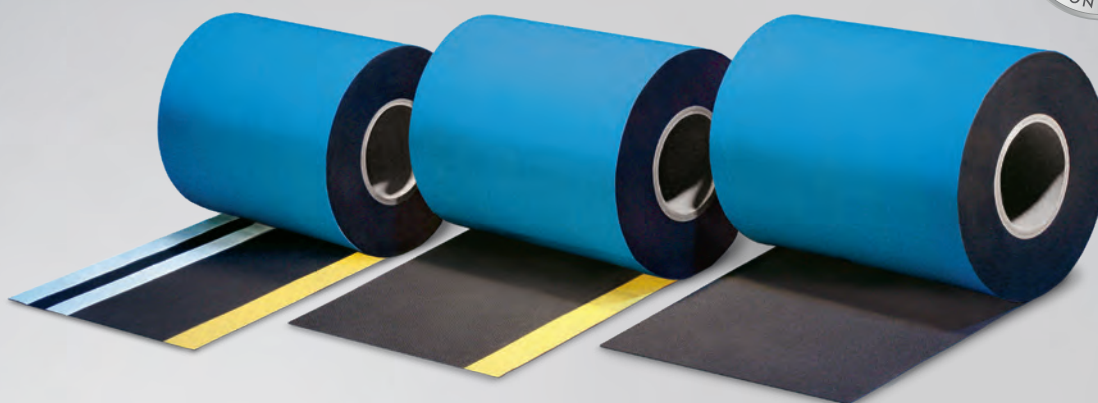

PRODUCT DESCRIPTION

ISO-CONNECT OUTSIDE EPDM is an elastomeric sealing band which serves as an external sealant on windows and facades in accordance with DIN 18531 and DIN 18533. ISO-CONNECT OUTSIDE EPDM is particularly suitable for external facade and window sealing projects. It has a thickness of ≥ 1.1 mm and conforms with the DIN-requirements.

APPLICATION

ISO-CONNECT OUTSIDE EPDM is a special outer sealant, designed in accordance with DIN 18195, for building structures and used as the complete perimeter seal and / or the base seal for doorways and floor fitting windows. In addition it is exceptionally suitable for the external sealing of structural building facades, making ISO-CONNECT OUTSIDE EPDM a versatile and proven sealing product compatible with all major building materials.

FINISHES

- Finish A: without self-adhesive
- Finish B: SK
single side self-adhesive with 1 self-adhesive strip
- Finish C: BT
single side self-adhesive with 1 or 2 butyl-adhesive strips, subject to product width
- Finish D: SK-BT
single side self-adhesive with 1 self-adhesive strip and 1 or 2 butyl-adhesive strips, subject to product width

PRODUCT ADVANTAGES

- permanent outer sealant
- high elasticity – compensates for joint movement
- extreme temperature and weather resistant
- bitumen compatible
- complies with the requirements of the Building Energy Act (EnEV was valid 31.10.20) and the recommendations of the RAL “installation guide”
- 10 Year Function Warranty*

* On the conditions of the manufacturer (available on request).

DIMENSIONS

width: 100, 150, 200, 250, 300, 400, 500 mm
alternative dimensions available on request

PACKAGING

rolls, roll length: 25 m

PREPARATION

Unroll ISO-CONNECT OUTSIDE EPDM elastomer sealing band and cut to the required length. The surface must be clean, dry and free from solvents, grease, dust, oil and other anti-adhesive substances.

Technical data	Standard	Classification
Material description		synthetic caoutchouc on EPDM basis
Colour		black
Building material class	DIN EN 13501	E
Impermeable to driving rain	DIN EN 1027	≥ 1,050 Pa
Bitumen compatible	DIN 7864 T1	bitumen compatible
UV stability	DIN 7864 T1	UV resistant
sd-value	DIN EN ISO 12572	0.8 mm approx. 25.6 m / 1.2 mm approx. 38.4 m
Ozone resistance	DIN 7864 T1	ozone resistant
Water vapour diffusion resistance μ	DIN EN 1931	≈ 32,000
Material thickness		0.8 mm and 1.2 mm
Elongation at break	DIN 53504	≥ 300 %
Tensile strength	DIN 53504	≥ 6.5 mPa
Maximum tear resistance	DIN 53504	≥ 25 kN/m
Temperature stability range		-30°C to +100°C
Handling temperature		+5°C to +35°C
Dimension tolerance	DIN 7715 T5 P3	requirements fulfilled
Storage temperature		+1°C to +25°C
Shelf life		unlimited (EPDM), finishes with adhesive strips 12 months, dry and in original packing

DIRECTIONS FOR USE

To generate an air tight seal, bond one edge of the band with a gunnable solvent free adhesive such as ISO-TOP FLEX-ADHESIVE XP and fix the other edge with mechanical fixings, e.g. clamps or components of the window system as described in DIN 18531 and DIN 18533. Alternatively, finish B and D are supplied with an acrylic adhesive strip to assist attaching the end to the aluminium window until the mechanical fixings are installed, or a gunned adhesive is applied. When using finishes with butyl-adhesive, pre-treat any porous and absorbent surfaces with ISO-TOP BLUE PRIMER and then apply the self-adhesive material to the surface. For all adhesive areas use a roller to carefully apply pressure to the area until the product adopts the contours of the facade. Butyl caoutchouc adhesives are sensitive to solvents. When bonding the complete surface, using a solvent based contact adhesive, coat both the band and the substrate and then carefully press into place.

ISO-CONNECT EPDM SEALING CORNERS

To supplement ISO-CONNECT OUTSIDE EPDM, we also supply moulded EPDM sealing corners for various connection areas on buildings. These can be used for in front of wall elements, for the lower connection area, on floor-level elements, balcony doors and patio door systems. For further information, see datasheet of ISO-CONNECT EPDM SEALING COLLAR AND SEALING CORNER.

DIMENSIONS SEALING CORNERS

inside corner: 100 x 100 x 100 mm (thickness 0.75 and 1.2 mm)
outside corner: 200 x 200 x 100 mm (thickness 0.75 and 1.2 mm)

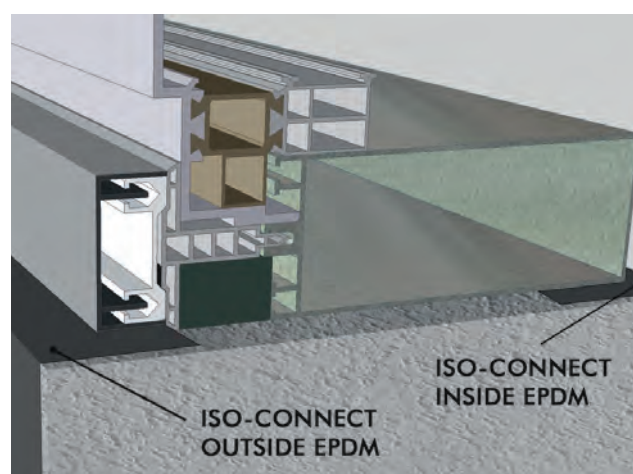

Installation example: ISO³-WINDOW SEALING SYSTEM

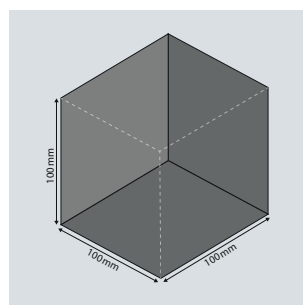

inside corner

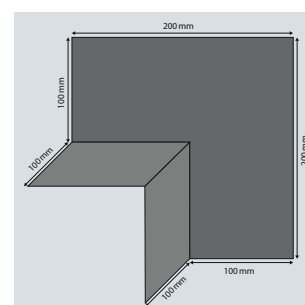

outside corner

ISO-CONNECT EPDM SEALING COLLAR AND SEALING CORNER



PRODUCT DESCRIPTION

ISO-CONNECT EPDM SEALING COLLAR is a elastomer sealing system. It is used for external sealing of window and door elements that are installed in the facade with metal angles in front of the load-bearing wall. This makes the system particularly suitable for in front of wall sealing in external applications. It conforms to DIN requirements. The vulcanised corner connections create a long-lasting seal and are very fast to install.

APPLICATION

ISO-CONNECT EPDM SEALING COLLAR is designed for structurally correct external sealing of door and window connections and can be used for all types of windows. It is ideal for the external sealing of structural elements in the facade area. ISO-CONNECT EPDM SEALING COLLAR is a versatile and proven sealing foil for use in PVC, wood, metal, window and facade constructions.

The sealing collars are made from highly flexible EPDM and are individually tailored for the application. They can be quickly fitted to the window using the optional butyl-adhesive or a suitable eurogroove gasket. A fitter places the prefabricated collar around the window in front of the wall, bonding it correctly to the supporting masonry wall. This simple and reliable seal can be fitted up to 6 times faster than a seal with foil strips.

PRODUCT ADVANTAGES

- permanent outer sealant
- high elasticity – compensates for joint movement
- extreme temperature and weather resistant
- eurogroove gasket range suitable for many PVC and aluminium systems
- installation time up to 6 times faster than sealing with foil strips
- custom-fit to external window dimensions
- complies with the requirements of the Building Energy Act (EnEV was valid 31.10.20) and the recommendations of the RAL "installation guide"
- 10 Year Function Warranty*

* On the conditions of the manufacturer (available on request).

ACCESSORIES

ISO-TOP FLEX-ADHESIVE XP for bonding to the masonry

PATENT-PENDING

Technical data	Standard	Classification
Material description		synthetic caoutchouc on EPDM basis
Colour		black
Building material class	DIN EN 13501-1	E
Air permeability coefficient	DIN EN 12114	$\alpha \ll 0.1$ (no measurable air penetration)
Bitumen compatible	DIN 7864 T1	bitumen compatible
UV stability	DIN 7864 T1	UV resistant
Ozone resistance	DIN 7864 T1	ozone resistant
Water vapour diffusion resistance μ	DIN EN 1931	60,000 +/- 18,000
Material thickness		0.8mm and 1.2mm
Elongation at break	DIN EN 12311-1	$\geq 450\%$
Tensile strength	DIN EN 12311-1	$\geq 350\text{N}/50\text{mm}$
Maximum tear resistance	DIN EN 12310-1	$\geq 90\text{N}$
Temperature stability range		-30°C to +110°C
Handling temperature		+5°C to +35°C
Dimension tolerance	DIN 7715 T5 P3	requirements fulfilled
Storage temperature		+1°C to +25°C
Shelf life		unlimited (EPDM with eurogroove gasket), finishes with adhesive strips 12 months, dry and in original packing

FINISHES

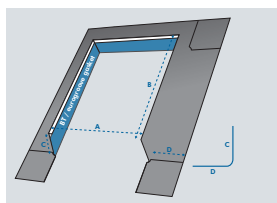

FINISH A

- 3-sided, without front part
- without self-adhesive
- with butyl-adhesive strip (BT)
- with eurogroove gasket (K)*

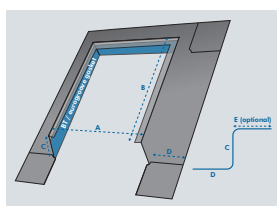

FINISH B

- 3-sided, with front part (E)
- without self-adhesive
- with butyl-adhesive strip (BT)
- with eurogroove gasket (K)*

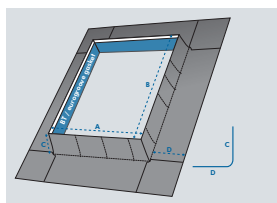

FINISH C

- 4-sided, without front part
- without self-adhesive
- with butyl-adhesive strip (BT)
- with eurogroove gasket (K)*

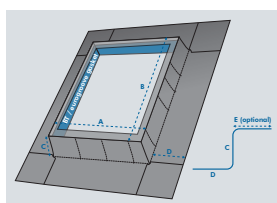

FINISH D

- 4-sided, with front part (E)
- without self-adhesive
- with butyl-adhesive strip (BT)
- with eurogroove gasket (K)*

* For eurogroove gasket range, see sketches on the right.
K3 and K6 = minimum order quantity 2,000 m.

ISO-CONNECT EPDM SEALING CORNERS

Alternatively, we also supply moulded EPDM sealing corners for various connection areas on buildings. These can be used for in front of wall elements, for the lower connection area, on floor-level elements, balcony doors and patio door systems. The material thicknesses and properties correspond to those of the ISO-CONNECT EPDM SEALING COLLAR.

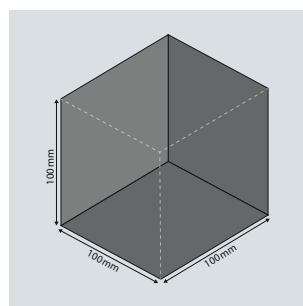

inside corner

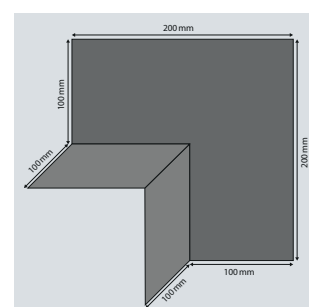

outside corner

DIMENSIONS SEALING CORNERS

inside corner: 100 x 100 x 100 mm

outside corner: 200 x 200 x 100 mm

K1



K2

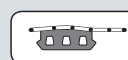

K3

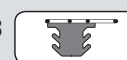

K4



K5



K6

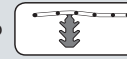

ISO-CONNECT HB-BAND

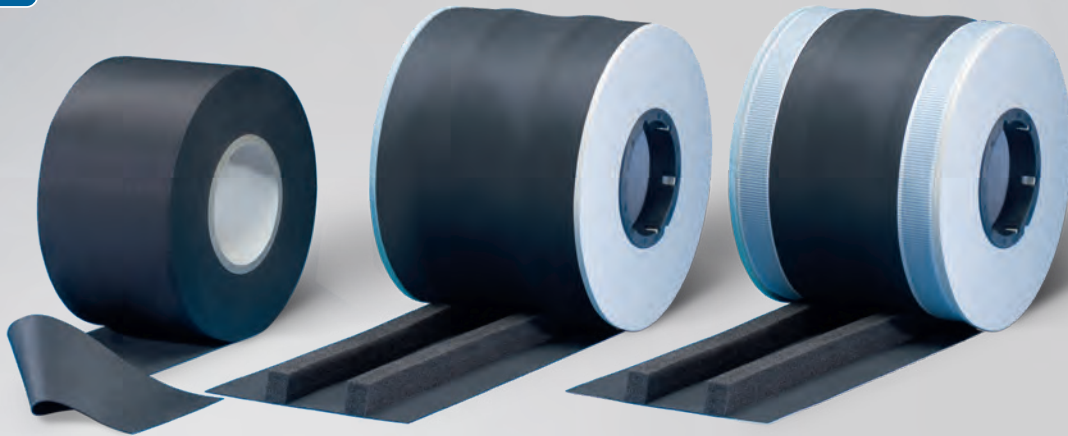

PRODUCT DESCRIPTION

ISO-CONNECT HB-BAND is a highly pressure-resistant sealing strip that is primarily used in timber-framed buildings between the wall sole plate and foundation wall / floor slab as a capillary barrier. It is ideal for sealing against rising damp.

It can be supplied ready prepared with:

- two impregnated foam strips for absorbing tolerances and compensating for irregular masonry surfaces
- two butyl self-adhesive strips for permanent fixing

APPLICATION

ISO-CONNECT HB-BAND is a specially-designed horizontal seal for timber-framed buildings. It prevents moisture migration from the supporting structure to the wall sole plate. With the addition of the impregnated foam strips, it also aids the airtightness and the thermal insulation between the two varying surfaces.

DIMENSIONS

thickness: 0.8 mm (plus impregnated tape, if added)
width: 120, 140, 150, 200, 250, 300, 400 mm
alternative dimensions available on request

PRODUCT ADVANTAGES

- permanent seal
- highly pressure-resistant
- excellent resistance to tearing
- weather resistant and UV stable
- impermeable to water vapour
- bitumen-compatible
- extremely temperature-resistant
- aids airtightness and thermal insulation
- flexible, even at low temperatures

FINISHES

- Finish 1: standard
- Finish 2: VK
with 2 impregnated foam strips (15x20 mm)
- Finish 3: VK-BT
with 2 impregnated foam strips (15x20 mm)
and 2 butyl-adhesive strips (20 mm)

PACKAGING

rolls, roll length: 25 m

Technical data	Standard	Classification
Material description		synthetic caoutchouc on EPDM basis
Colour		black
Building material class	DIN 13501 T1	E
UV stability and ozone resistance	DIN 7864 T1	requirements fulfilled
Water vapour diffusion resistance μ	DIN EN 1931	32,000
Maximum tear resistance	DIN 53504	≥ 25 kN/m
Tensile strength	DIN 53504	≥ 6.5 mPa
Elongation at break	DIN 53504	$\geq 300\%$
Handling temperature		+5°C to +35°C
Temperature stability range		-30°C to +100°C
Dimension tolerance	DIN 7715 TP P3	requirements fulfilled
Shelf life and storage temperature		EPDM: unlimited impregnated foam and butyl: 1 year at +1°C to +25°C

PROCESSING

Preparation of the substrate

The substrate must be clean, solid, dry and free of solvents.

Using ISO-CONNECT HB-BAND

Run the ISO-CONNECT HB-BAND along the length of either the sole plate, or the foundation wall. Ensure it is flat, but do not stretch, and fix it to the substrate.

- Finish 1 and 2: Fix with staples or flat head nails.
- Finish 3: Fix with double-sided butyl-adhesive tape.

Remove protective film from the adhesive tape, apply the adhesive tape to the substrate and press carefully with a roller. The sealing strip must not be pulled too tightly.

If tapes are joined, allow an overlap of 20 cm. ISO-CONNECT HB-BAND must protrude by roughly 1 – 2 cm on both sides to prevent damp bridges occurring on either side of the wall. The overlaps can be bonded with ISO-TOP FLEX-ADHESIVE XP.

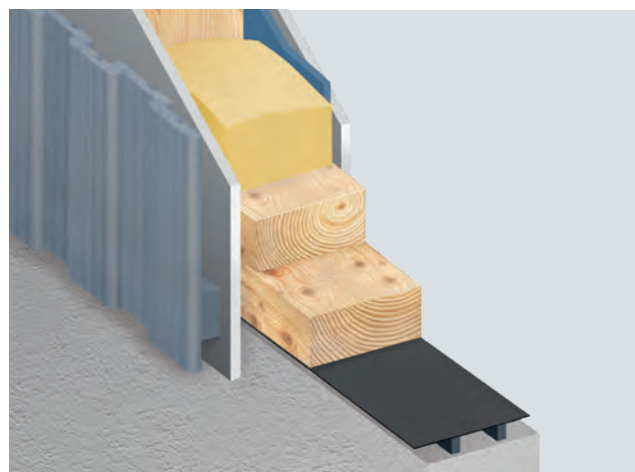
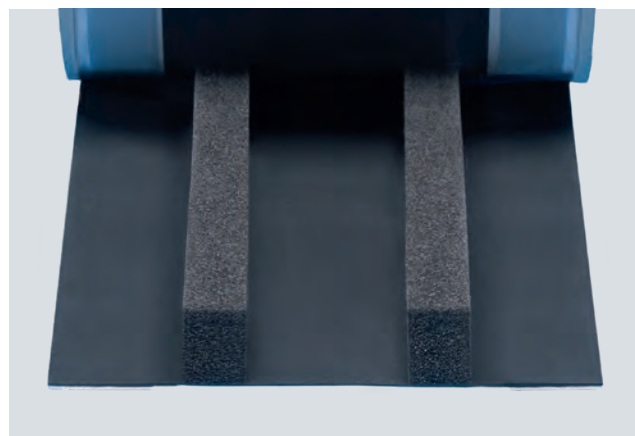

Installation example: ISO-CONNECT HB-BAND

ISO-CONNECT INSIDE **BLUE LINE**



PRODUCT DESCRIPTION

ISO-CONNECT INSIDE „BLUE LINE“ is a bio-based window connection foil for interior use, the basic component of which is obtained from renewable raw materials. The polymers used to manufacture it are based on sugar-containing plants such as sugar beet, sugarcane, corn, maize and similar species. These types of plant take up large quantities of CO₂ while they are growing. This in turn reduces actively harmful greenhouse gases, thus contributing to a balanced climate.

Sustainably produced foils such as ISO-CONNECT INSIDE „BLUE LINE“ nevertheless provide the same technical properties as foils based on purely synthetic raw materials. ISO-CONNECT INSIDE „BLUE LINE“ is a flexible and stretchable special foil for connection joints on windows, doors and panels to create a seal that is both air and wind tight. The soft and very adaptable window connection foil has an acrylate self-adhesive strip for quick and effective application to window frames. ISO-CONNECT INSIDE „BLUE LINE“ creates a vapour diffusion barrier and prevents the risk of condensation in the functional area. This meets the requirements of the Building Energy Act GEG (EnEV was vaild 31.10.20) as well as the RAL “installation guide”.

PRODUCT ADVANTAGES

- bio-based and sustainably produced
- environment and climate-friendly
- creates a healthy living environment and emission-free
- high elasticity and flexible adaptation, compensates joint movement
- low inherent rigidity and at the same time high ultimate tensile strength for easy and effective application
- air tight, wind proof and vapour diffusion retardant
- driving rain and water resistant
- special fleece surface to enable plastering, painting or pasting over
- with self-adhesive strip for easy installation
- complies with the requirements of the Building Energy Act (EnEV was vaild 31.10.20) and the recommendations of the RAL “installation guide”
- 10 Year Function Warranty*

* On the conditions of the manufacturer (available on request).

SERVICE

- standard sizes available from stock
- competent experienced technical support available in the field and by phone
- advice on installation and instruction on site



Technical data	Standard	Classification
Material description		bio-based polymer foil based on renewable raw materials
Colour		white
Impermeable to driving rain, single joint	DIN EN 1027	≥ 1,050Pa
Air permeability coefficient	DIN EN 12114	a << 0.1 (no measurable air penetration)
UV stability		approx. 3 months
Temperature stability range	internal	approx. -40 °C to +80 °C
sd-value	DIN EN ISO 12572	approx. 20m
Flexibility at -23 °C.	internal	no breaks, no tears
Fire behaviour	DIN EN 13501	E
Dimension tolerance	DIN 7715 T5 P3	requirements fulfilled
Handling temperature		+5 °C to approx. +45 °C
Shelf life		1 year, dry and in original packing
Storage temperature		+1 °C to +20 °C

APPLICATION

ISO-CONNECT INSIDE „BLUE LINE“ is a component from the „BLUE LINE“ organic product range. It is used as an air tight level application over connection joints on the inside of the building structure. The adaptable bio-based special foil is very flexible in its application and is characterised through its low inherent rigidity, allowing problem-free application around corners and conforms to different shapes. The material's high elasticity makes it particularly suitable for the reliable sealing of movement joints. Due to the extremely high elasticity of the material it is particularly suitable for the reliable sealing of moving joints. Even on extreme movements between elements the flexible window connecting film ensures a high ultimate tensile strength.

PROCESSING

The bonding surfaces must be firm, clean from dust, stripping agents, solvents, oil and grease. When sealing window, panel and door frame connections, remove backing from the self-adhesive strip, then place the foil into position, press and roll down firmly. ISO-CONNECT INSIDE „BLUE LINE“ can be applied in the factory or workshop.

For bonding to walls ISO-TOP FLEX-ADHESIVE SP or XP (follow the ISO-TOP FLEX-ADHESIVE product data sheet) is used. Normal rough, e.g. uneven wall surfaces, can be compensated for through the application of a sufficient amount of adhesive. Use sufficient adhesive so that after applying and rolling the foil the adhesive caterpillar is at least 30 mm wide and 1 mm thick. In areas that are to be plastered over, a full-surface adhesive layer should be applied. Plastering can be done as soon as the adhesive is sufficiently cured to carry the plaster.

FINISHES

single side self-adhesive with 1 self-adhesive strip
special finishes available on request

DIMENSIONS

width: 70, 90, 145, 180, 235, 290 mm

PACKAGING

rolls, roll length: 30 m

ISO-CONNECT OUTSIDE BLUE LINE



PRODUCT DESCRIPTION

ISO-CONNECT OUTSIDE „BLUE LINE“ is a bio-based window connection foil for exterior use, the basic component of which is obtained from renewable raw materials. The polymers used to manufacture it are based on sugar-containing plants such as sugar beet, sugarcane, corn, maize and similar species. These types of plant take up large quantities of CO₂ while they are growing. This in turn reduces actively harmful greenhouse gases, thus contributing to a balanced climate.

Sustainably produced foils such as ISO-CONNECT OUTSIDE „BLUE LINE“ nevertheless provide the same technical properties as foils based on purely synthetic raw materials. ISO-CONNECT OUTSIDE „BLUE LINE“ is a flexible and stretchable special foil for connection joints on windows, doors and panels to create a seal that is both air tight and impermeable to driving rain. The soft and very adaptable window connection foil has an acrylate self-adhesive strip for quick and effective application to window frames. ISO-CONNECT OUTSIDE „BLUE LINE“ allows vapour diffusion and allows moisture to escape to the outside. This meets the requirements of the Building Energy Act GEG (EnEV was vaild 31.10.20) as well as the RAL “installation guide”.

PRODUCT ADVANTAGES

- bio-based and sustainably produced
- environment and climate-friendly
- creates a healthy living environment and emission-free
- high elasticity and flexible adaptation, compensates joint movement
- low inherent rigidity and at the same time high ultimate tensile strength for easy and effective application
- air tight, wind proof and vapour diffusion permeable
- driving rain and water resistant
- special fleece surface to enable plastering, painting or pasting over
- with self-adhesive strip for easy installation
- complies with the requirements of the Building Energy Act (EnEV was vaild 31.10.20) and the recommendations of the RAL “installation guide”
- 10 Year Function Warranty*

* On the conditions of the manufacturer (available on request).

SERVICE

- standard sizes available from stock
- competent experienced technical support available in the field and by phone
- advice on installation and instruction on site



Technical data	Standard	Classification
Material description		bio-based polymer foil based on renewable raw materials
Colour		white
Impermeable to driving rain, single joint	DIN EN 1027	$\geq 1,050\text{Pa}$
Air permeability coefficient	DIN EN 12114	$a \ll 0.1$ (no measurable air penetration)
UV stability		approx. 3 months
Temperature stability range	internal	approx. -40 °C to $+80\text{ °C}$
sd-value	DIN EN ISO 12572	approx. 0.5 m
Flexibility at -23 °C .	internal	no breaks, no tears
Fire behaviour	DIN EN 13501	E
Dimension tolerance	DIN 7715 T5 P3	requirements fulfilled
Handling temperature		$+5\text{ °C}$ to approx. $+45\text{ °C}$
Shelf life		1 year, dry and in original packing
Storage temperature		$+1\text{ °C}$ to $+20\text{ °C}$

APPLICATION

ISO-CONNECT OUTSIDE „BLUE LINE“ is a component from the „BLUE LINE“ organic product range. It is used as weather protection for bonding over connection joints on the outside structure of buildings. The adaptable bio-based special foil is very flexible in its application and is characterised through its low inherent rigidity, allowing problem-free application around corners and conforms to different shapes. The material's high elasticity makes it particularly suitable for the reliable sealing of movement joints. Due to the extremely high elasticity of the material it is particularly suitable for the reliable sealing of moving joints. Even on extreme movements between elements the flexible window connecting film ensures a high ultimate tensile strength.

PROCESSING

The bonding surfaces must be firm, clean from dust, stripping agents, solvents, oil and grease. When sealing window, panel and door frame connections, remove backing from the self-adhesive strip, then place the foil into position, press and roll down firmly. ISO-CONNECT OUTSIDE „BLUE LINE“ can be applied in the factory or workshop.

For bonding to walls ISO-TOP FLEX-ADHESIVE SP or XP (follow the ISO-TOP FLEX-ADHESIVE product data sheet) is used. Normal rough, e.g. uneven wall surfaces, can be compensated for through the application of a sufficient amount of adhesive. Use sufficient adhesive so that after applying and rolling the foil the adhesive caterpillar is at least 30 mm wide and 1 mm thick. In areas that are to be plastered over, a full-surface adhesive layer should be applied. Plastering can be done as soon as the adhesive is sufficiently cured to carry the plaster.

FINISHES

single side self-adhesive with 1 self-adhesive strip
special finishes available on request

DIMENSIONS

width: 70, 90, 145, 180, 235, 290 mm

PACKAGING

rolls, roll length: 30 m

ISO-CONNECT INSIDE FD



PRODUCT DESCRIPTION

ISO-CONNECT INSIDE FD is an extremely flexible and stretchable special foil for an air and vapour tight seal on window, door and panel connecting joints.

ISO-CONNECT INSIDE FD consists of a flexible soft synthetic fleece, which is equipped with a self-adhesive strip on one edge for easy and effective application on window and door frames. The water vapour diffusion retardant fleece membrane provides a reliable separation between internal and external conditions and complies with the requirements of the Building Energy Act (EnEV was vaild 31.10.20) as well as the RAL "installation guide".

APPLICATION

ISO-CONNECT INSIDE FD is a system component of the ISO³-WINDOW SEALING SYSTEM and is used to seal internal window and door connecting joints.

The special versatile foil is very flexible in its application and is characterised through its low inherent rigidity, allowing problem-free application around corners and conforms to different shapes.

Due to the extremely high elasticity of the material it is particularly suitable for the reliable sealing of moving joints. Even on extreme movements between elements the flexible window connecting film ensures a high ultimate tensile strength.

PRODUCT ADVANTAGES

- high elasticity and flexible adaptation, compensates joint movement
- low inherent rigidity and at the same time high ultimate tensile strength for easy and effective application
- air tight, wind proof and vapour diffusion retardant
- driving rain and water resistant
- special fleece surface to enable plastering, painting or pasting over
- with self-adhesive strip for easy installation
- complies with the requirements of the Building Energy Act (EnEV was vaild 31.10.20) and the recommendations of the RAL "installation guide"
- 10 Year Function Warranty*

* On the conditions of the manufacturer (available on request).

SERVICE

- standard sizes available from stock
- private label and / or special labelling available
- competent experienced technical support available in the field and by phone

DIMENSIONS

width finish SK: 70, 90, 145, 180, 235, 290 mm
width finish COMPLETE: 70, 100, 140, 200 mm
width finish COMPLETE DUO: 70, 100, 140 mm

Technical data	Standard	Classification
Material description		vapour diffusion impermeable synthetic fleece
Colour		blue
Weight		approx. 180g/m ²
Impermeable to driving rain	DIN EN 1027	≥ 1,050 Pa
Air permeability coefficient	DIN EN 12114	a << 0.1 (no measurable air penetration)
UV stability		approx. 3 months
Temperature stability range	internal	approx. -40°C to +80°C
sd-value	DIN EN ISO 12572	approx. 39 m
Flexibility at -23°C	internal	no breaks, no tears
Fire behaviour	DIN EN 13501	E
Dimension tolerance	DIN 7715 T5 P3	requirements fulfilled
Handling temperature		+5°C to approx. +45°C
Shelf life		1 year, dry and in original packing
Storage temperature		+1°C to +20°C

PROCESSING

The bonding surfaces must be firm, dry, clean from dust, stripping agents, solvents, oil and grease. When sealing window, panel and door frame connections, remove backing from the self-adhesive strip, then place the foil into position and press firmly. ISO-CONNECT INSIDE FD can be applied in the factory or workshop.

For bonding to walls ISO-TOP FLEX-ADHESIVE SP is used. Normal rough, e.g. uneven wall surfaces, can be compensated for through the application of a sufficient amount of adhesive. Use sufficient adhesive so that after applying the foil the adhesive caterpillar is at least 30mm wide and 1 mm thick. On areas that are to be plastered over a continuous "Z" shaped caterpillar should be applied over the area. On smooth wall surfaces the fully self-adhesive finishes COMPLETE and COMPLETE DUO do not require any additional adhesion with ISO-TOP FLEX ADHESIVE. Overlapping of the foil ends should be up to 50mm wide using the same technique. Plastering can be done as soon as the adhesive is sufficiently cured to carry the plaster.

FINISHES

- finish SK: single side self-adhesive with 1 self-adhesive strip
- finish COMPLETE: full surface adhesive finish with a 2-way or 3-way split liner
- finish COMPLETE DUO: full surface adhesive finish with a 2-way or 3-way split liner and 1 self-adhesive strip (window mounting)
- special finishes available on request

PACKAGING

rolls, roll length: 30m

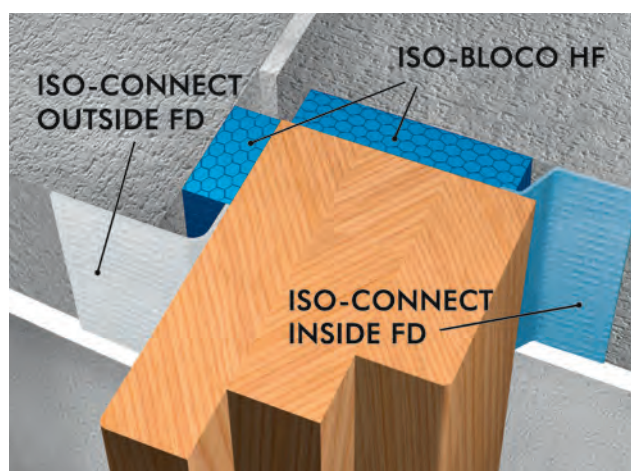

Installation example: ISO³-WINDOW SEALING SYSTEM

ISO-PROFIL FILLER STRIPS



PRODUCT DESCRIPTION

ISO-PROFIL FILLER STRIPS are profile cut strips of high-quality PE foam material. They are used in metal and industrial building structures to seal and insulate trapezoidal and wave profile sheets. They have the optimum form to match a wide range of European manufactured trapezoidal and corrugated metal sheeting.

APPLICATION

ISO-PROFIL FILLER STRIPS are specially designed for the reliable and durable sealing of trapezoidal and corrugated metal sheeting, with additional heat and sound insulation. They are used for sealing applications in roofing (roof ridge, eaves) as well as for facades (parapet connections).

SERVICE

- standard profiles available at short notice
- special profiles on request
- product delivery direct to the building site
- competent commercial and technical support

MATERIAL THICKNESS

approx. 30 or approx. 50 mm

PRODUCT ADVANTAGES

- exact fit and dimensions for every trapezoidal sheet
- fine cells with a consistent smooth surface
- permanently elastic as well as having form stability
- environmentally friendly – chemically neutral
- available with UV resistant aluminium lamination
- fire protection class B2
- two-coloured for increased flexibility when installing
- complies with the IFBS technical rules for lightweight metal construction
- high and regularly examined product quality

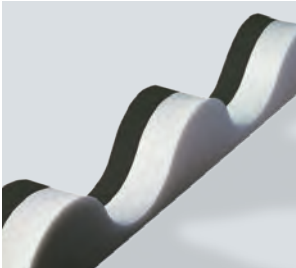

FINISHES***STANDARD MODELS**

two-coloured anthracite / white, for a reliable and durable sealing of trapezoid and wave profiles on building constructions

**SPECIAL COLOUR**

in anthracite or white as an alternative colour variety, should a single colour play a special roll on an installation

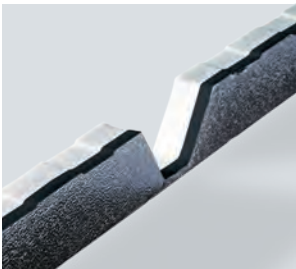
**ALUMINIUM LAMINATED**

an additional protection against UV radiation and for a higher ageing resistance

**SELF-ADHESIVE**

with butyl tape to simplify assembly and as additional sealing

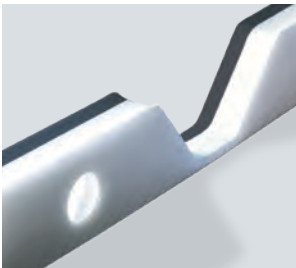
**VENTILATION VENTS**

to improve the ventilation of air in building constructions

* Special properties available on request.

ISO-PROFIL FILLER PIECES

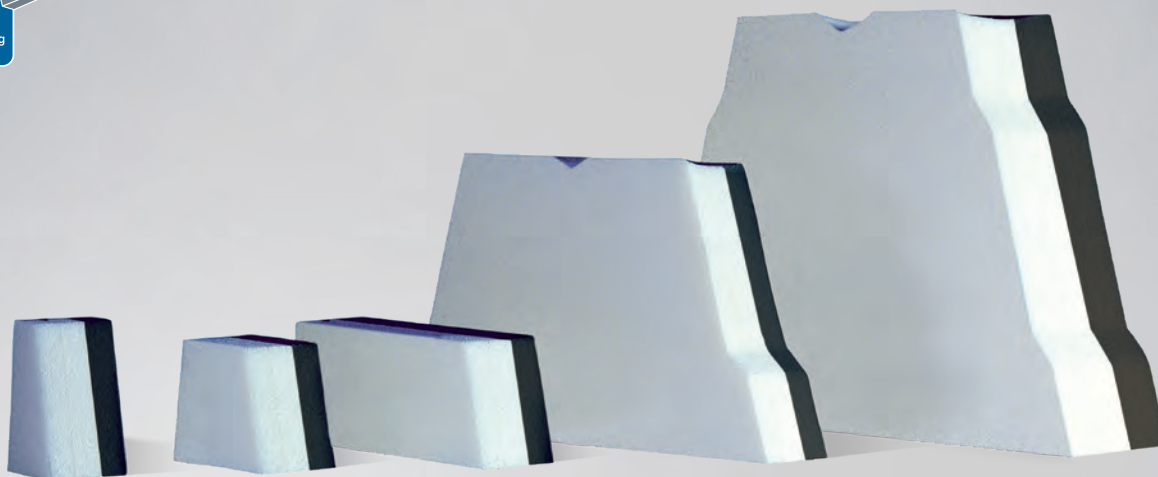

PRODUCT DESCRIPTION

ISO-PROFIL FILLER PIECES are exact matching foam profiles of high-quality polyethylene, which are predominantly applied as sealing and insulation to existing trapezoidal sheeting. They have the optimum shape for a wide range of European manufactured trapezoidal and corrugated sheeting.

APPLICATION

ISO-PROFIL FILLER PIECES are used in metal and trapezoidal sheeting constructions. They are specially designed for the installation of additional partition walls as well as in the roof and facade areas. They are easily installed in the finished assembled trapezoidal sheets and give a reliable and durable seal with thermal insulation.

SERVICE

- standard profiles available at short notice
- special profiles on request
- product delivery direct to the building site
- competent commercial and technical support

MATERIAL THICKNESS

- PE pieces: approx. 30 or approx. 50 mm
- A1 pieces: approx. 50 or approx. 100 mm

PRODUCT ADVANTAGES

- problem-free retrospective installation
- exact fit and dimensions for every trapezoidal sheet
- permanently elastic as well as having form stability
- fine cells with a consistent smooth surface
- environmentally friendly – chemically neutral
- available with UV resistant aluminium lamination
- fire protection class B2
- two-coloured for more colour handling flexibility when installing
- high and regularly examined product quality
- complies with the IFBS technical rules for lightweight metal construction



Installation example: ISO-PROFIL FILLER PIECES

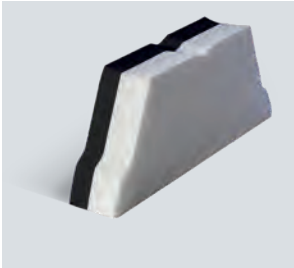

FINISHES***STANDARD MODELS**

two-coloured anthracite / white, for a reliable and durable sealing of trapezoid and wave profiles on building constructions

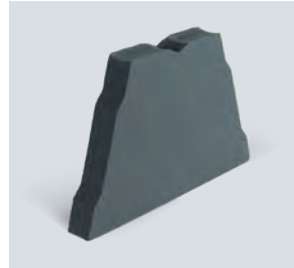
**SPECIAL COLOUR**

in anthracite or white as an alternative colour variety, should a single colour play a special roll on an installation

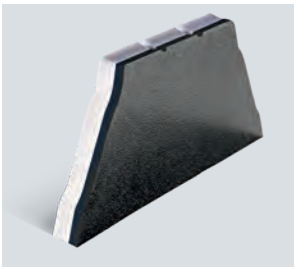
**ALUMINIUM LAMINATED**

an additional protection against UV radiation and for a higher ageing resistance

**MINERAL FIBRES**

non-flammable, A1 for the installation in fire protection walls and partitions

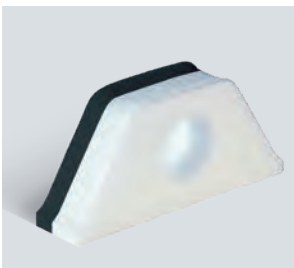
**VENTILATION VENTS**

to improve the ventilation of air in building constructions

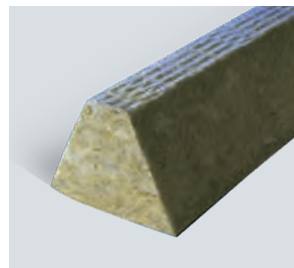
**TRAPEZOID POLE**

from mineral fibres or PE-foam for the solution of sound and heat insulation in hall constructions

* Special properties available on request.

ISO-TOP FLEX-ADHESIVE HP



PRODUCT DESCRIPTION

ISO-TOP FLEX-ADHESIVE HP is a high-quality, solvent-free and permanently flexible single-component construction adhesive based on MS polymer. With its excellent bonding characteristics, it is ideal for creating airtight and windtight connections that are also impermeable to driving rain when used in combination with ISO-CONNECT window connection foils. ISO-TOP FLEX-ADHESIVE HP is also recommended for bonding trims made from PVC and wood when such applications require premium quality bonding onto standard structural materials such as wood, stone, concrete, glass, metal and plastic.

APPLICATION

- bonding and sealing when using window connection foils such as ISO-CONNECT INSIDE & OUTSIDE „BLUE LINE“, INSIDE FD, VARIO SD and XD (fleece and foil sides), construction foils, joint sealing tapes such as ISO-BLOCO 300 & 600 and multi-functional joint sealing tapes such as ISO-BLOCO ONE (for forming corners)
- use in connection joints, e.g. between facade elements, connection joints around window frames, joints in the masonry, concrete, etc.
- bonding of COMPLETE finishes to difficult substrates
- joint seals in facades, walls and floors
- bonding in the vicinity of structural components made from all standard materials such as plaster edges, window walls, panels, sheets and prefabricated elements

PRODUCT ADVANTAGES

- very good usually primerless adhesion to almost all surfaces
 - for air-impermeable connections in accordance with RAL, DIN 4108-7, GEG, and Austrian standards
 - tested adhesive for bonding ISO-CONNECT window connection foils
 - flexible sealing adhesive
 - suitable for bonding to natural stone
 - very low-emission (EC1^{PLUS})
 - great resistance to ageing, weather and UV
 - contains no solvents, isocyanates, halogens or acids
 - constant quality, DIN-standards which are regularly examined by external institutions
 - conforms to EN 15651-1: 25 HM
 - compatible with paint coatings / can be painted over
- bonding of joints adjacent to or between natural stone blocks
 - adhesive for repairing existing MS polymer and hybrid polymer defects



Technical data	Standard	Classification
Colour		white
Base material		MS polymer
Curing		moisture-curing
Consistency		low-viscosity – paste-like
Density in g/cm ³	DIN 53479 DIN EN ISO 845	approx. 1.4
Skin forming*		approx. 20 minutes
Curing speed*		approx. 2 mm/24 h
GEV-EMICODE®		EC1 ^{plus}
Temperature stability range		-40°C to +100°C
Yield		coverage depending on surface structure and for an 8 mm bead, approx. 10 m / tubular bag
Shore A hardness	DIN EN ISO 868	approx. 35
Elasticity module	DIN 53504	0.73 N/mm ²
Tensile strength	DIN 53504	approx. 1.28 N/mm ²
Elongation at break		> 300%
sd-value		approx. 3.9 m for 10 mm
Building material class / fire behaviour	DIN EN 13501-1	class E
Processing temperature		+5°C to +40°C lowest application temperature -5°C, depending on surface, material and external temperature
Shelf life		12 months, in original packaging and stored dry
Storage temperature		+5°C to +40°C

* Measured in accordance with DIN EN ISO 291 standard climate at 23°C / 50 % RH, values can vary through environmental factors (temperature, moisture, surface).

PROCESSING

The application surface must be dry, sound, stable and free of cleaning agents such as dust, oil and fat. Fill out large surface voids in advance. Normal surface irregularities can be compensated by applying sufficient adhesive. Porous surfaces can, if necessary, be pre-treated with ISO-TOP BLUE PRIMER. Apply bead of 8 to 10 mm on to the surface. Apply the foil, fleece, paperboard or paper without tension; meaning with a loop on to the freshly (no build up of skin) applied adhesive bead and press down lightly with appropriate tools. When installing window foil sealants apply sufficient ISO-TOP FLEX-ADHESIVE HP to assure that after the window foil has been rolled into place the width of the adhesive is at least 30 mm wide and at least 1 mm thick. According to related standards (e.g. DIN 18540) elastic sealants should not be completely painted over, as tension and movement in the non-elastic paint may occur and could cause cracking. Suitable for all conventional substrates such as anodised aluminium, concrete, stainless steel, iron, fibre cement, plasterboard, glass, wood, sand-lime brick, ceramic, plastic strip, copper, natural stone / marble, aircrete, plaster, PVC, expanded polystyrene, zinc, etc. It is advisable to do a preliminary bonding and compatibility test on all surfaces. Not suitable for PP, PE, PTFE, neoprene, silicone and bituminous substrates.

WORK SAFETY

Please refer to our EC safety data sheets for hazards, safety tips and storage, disposal and transportation marking.

PACKAGING

12 tubular bags (of 600 ml) per box including application nozzle

ACCESSORIES

ISO-TOP PRESSFIX for efficient application

ISO-TOP FLEX-ADHESIVE



PRODUCT DESCRIPTION

ISO-TOP FLEX-ADHESIVES are high quality sealants and adhesives, with a wide adhesive spectrum.

APPLICATION

ISO-TOP FLEX-ADHESIVES are specially designed reliable bonding agents for window connections foils, fleece and paper in building constructions, providing an air-impermeable connection to masonry work.

They are suitable, in accordance to DIN 4108-7, for a reliable, air-impermeable bonding on window connections foils.

SERVICE

- standard sizes available from stock
- competent experienced technical support available in the field and by phone

PACKAGING

- ISO-TOP FLEX-ADHESIVE XP:
12 tubular bags (of 600 ml) per box
- ISO-TOP FLEX-ADHESIVE SP:
12 tubular bags (of 600 ml) per box
- ISO-TOP FLEX-ADHESIVE PA:
12 cartridges (of 310 ml) per box

PRODUCT ADVANTAGES

- ISO-TOP FLEX-ADHESIVES are suitable for air-impermeable connections in accordance with the application examples of DIN 4108-7
- makes an air-impermeable connection between foil and building structures (masonry work, concrete, stone, plaster and anodised aluminium) possible
- very good bond to all commercial window connection foils
- air-impermeable finish on openings
- DIN standardised quality and regulatory controls from external institutions



Installation example: ISO-TOP FLEX-ADHESIVE SP



Technical data	XP	SP	PA
Material description	soft elastic special polymer		
Colour	black	white	light blue
Base	MS Polymer, solvent-free	1-K-acrylate dispersion**	acrylate dispersion
Consistency	paste		
Density in g/ml	approx. 1.5	approx. 1.7	approx. 1.2
Application temperature:			
Ambient temperature	0°C to +40°C	+5°C to +40°C	+5°C to +40°C
Bonding surface temp.	0°C to +35°C	+5°C to +35°C	+5°C to +40°C
Curing process	polymerisation through humidity at room temperature	physical drying	physical drying
Temperature stability	-40°C to +90°C	-20°C to +80°C	-40°C to +100°C
Skin forming	approx. 10 minutes	approx. 20 minutes	permanently sticky
Curing speed*	approx. 2 mm/24 h	approx. 2 mm/24 h	-
GEV-EMICODE®	EC1 ^{plus}	-	-
Coverage	depending on surface structure and a 8 mm bead, approx. 10 m		8mm bead, approx. 6m
Building material class (DIN 4102 part 1)	B2		
Building material class 13501	class E		
Shelf life	in a cool and dry place (+5°C to +25°C) up to 12 months after production date	in a cool and dry place (+5°C to +25°C) up to 12 months after production date, protect from frost	in a cool and dry place (+5°C to +40°C) up to 24 months after production date
Especially suitable for	ISO-CONNECT - INSIDE & OUTSIDE CX - INSIDE & OUTSIDE FD - INSIDE & OUTSIDE EPDM - KSK SEAL - VARIO SD - VARIO XD (fleece & foil side) ISO-BLOCO - ONE (corner bonding) - 300 & 600 (additional sealing)	ISO-CONNECT - INSIDE & OUTSIDE CX - INSIDE & OUTSIDE FD - VARIO XD (fleece side)	ISO-CONNECT - INSIDE CX - INSIDE FD - VARIO SD & VARIO XD - INSIDE EPDM (perimeter area) - REVEALSEAL ISO-BLOCO - ONE, ONE CONTROL & RENO (corner bonding)

* Measured in accordance with DIN EN ISO 291 standard climate at 23°C / 50 % RH, values can vary through environmental factors (temperature, moisture, surface).

** Keep product protected against moisture and rain whilst curing.

PROCESSING

The application surface must be stable, firm, free of dust, cleaning agents, oil and fat. Fill out large surface voids in advance. Normal surface irregularities can be compensated by adding sufficient adhesive.

Porous surfaces can, if necessary, be pre-treated with ISO-TOP BLUE PRIMER. Apply bead of 8 to 10 mm on to the surface. Apply the foil, fleece, paperboard or paper without tension; meaning with a loop on to the freshly (no build up of skin) applied adhesive bead and press down lightly with appropriate tools. When installing window foil sealants apply sufficient ISO-TOP FLEX-ADHESIVE to assure that after the window foil has been pressed into place the width of the adhesive is at least 30 mm

wide and at least 1 mm thick. According to related standards (e.g. DIN 18540) elastic sealants should not be completely painted over, as tension and movement in the non-elastic paint may occur and could cause cracking. It is advisable to do a preliminary bonding and compatibility test on all surfaces.

WORK SAFETY

Please refer to our EC safety data sheets for hazards, safety tips and storage, disposal and transportation markings.

ISO-TOP FLEX-ADHESIVE WF



illustration purposes only

PRODUCT DESCRIPTION

ISO-TOP FLEX-ADHESIVE WF is a high-quality, neutral, single-component, permanently flexible adhesive and sealant on a hybrid polymer basis, specially developed for gluing and sealing the IN FRONT OF WALL INSTALLATION SYSTEM ISO-TOP WINFRAMER.

APPLICATION

- tension-free structural adhesion of the IN FRONT OF WALL INSTALLATION SYSTEM ISO-TOP WINFRAMER
- sealing and gluing applications for the corner connection and to the wall material

PROCESSING

ISO-TOP FLEX-ADHESIVE WF usually requires no primer and still has outstanding adhesive properties on numerous surfaces including aerated concrete, vertical coring bricks, limestone, sandstone, concrete, polystyrene and timber. The adhesive surfaces must have a sufficient load-bearing capacity and be clean, dust- and grease-free. Dry surfaces are particularly suitable; the best adhesive values are achieved here.

ISO-TOP FLEX-ADHESIVE WF also bonds to moist surfaces. However, the bond may be less strong than the one achieved for dry and clean surfaces. Porous surfaces such as aerated concrete with a high water load should be pre-treated with ISO-TOP BLUE PRIMER if necessary. It is advisable to carry out an adhesion and compatibility test on any surface before starting work.

PRODUCT ADVANTAGES

- high initial adhesion
- permanent sealing / gluing to the wall material
- very good processing
- very good usually primerless adhesion to almost all (even moist) surfaces
- permanently flexible after curing
- non-corrosive
- waterproof
- compensates unevenness and material tensions
- blister-free curing even at high temperatures
- free of silicone, solvents, halogens, acids and isocyanate
- can be painted over well as per DIN 52452-A1
- colour-fast, resistant to weathering and UV

Curing is effected by air humidity at room temperature and takes place from outside to inside, slowing as time progresses. At low temperature and / or low humidity, the curing process is slowed significantly.

For further information regarding the adhesion and sealing of the in front of wall installation system please refer to the installation instructions.



Technical data	Standard	Classification
Colour		white
Base		1-component hybrid polymer
Consistency		paste
Density in g/ml	DIN 53479	approx. 1.67
Curing system		polymerisation through air humidity at room temperature
Skin forming*		approx. 10 minutes
Curing speed*		2 to 3 mm/24h
Shore A hardness	DIN 53505	40 ± 5
Temperature stability range		-40°C to +90°C
Re-expansion capacity	ISO 7389-B	> 75%
Maximum permissible total deformation	DIN EN ISO 11 600	20%
Elasticity module 100%	DIN EN ISO 8339	0.75 N/mm ²
Tensile strength	DIN 53504	1.8 N/mm ²
Tensile shear strength (Surface: AlMgSi1 / Layer thickness: 2 mm / Feed speed: 10 mm per min.)	DIN 53504	0.9 N/mm ²
Elongation at break	DIN 53504	750%
Change in volume	DIN EN ISO 10563	-3 to -4 Vol.%
Fire behaviour	DIN 4102 Part 1	B2
Yield from 600 ml tubular bag depending on surface roughness		for triangular nozzle cut with opening size: - 6/6 mm approx. 20 m - 8/8 mm approx. 14 m
Processing temperature		+0°C (frost-free) up to +40°C (ambient temperature) +0°C (frost-free) up to +35°C (temperature of adhesive surfaces)
Shelf life		1 year, in original packaging and stored dry
Storage temperature		+5°C to +25°C

* Measured in accordance with DIN EN ISO 291 standard climate at 23°C / 50 % RH, values can vary through environmental factors (temperature, moisture, surface).

* If the specified triangular adhesive / sealant beads dimension is exceeded, the length output is reduced accordingly. With regard to the quantity used when installing ISO-TOP WINFRAMER components, the specifications of the installation instructions must also be observed. Use the ISO-TOP WINFRAMER CALCULATION TOOL in the ISO-PORTAL for precise calculation.

HEALTH AND SAFETY

Further information on product safety and handling can be found in the notes on the sales container and in the installation instructions of IN FRONT OF WALL INSTALLATION SYSTEM ISO-TOP WINFRAMER.

PACKAGING

12 tubular bags (of 600 ml) per box

ACCESSORIES

ISO-TOP PRESSFIX for efficient processing



Installation example: ISO-TOP FLEX-ADHESIVE WF

ISO-TOP BLUE PRIMER



PRODUCT DESCRIPTION

ISO-TOP BLUE PRIMER is a primer on an aqueous acrylate-polymer dispersion basis. It has been specially developed to improve the adhesion properties of acrylate, bitumen, butyl and hybrid polymer adhesives, as well as those of adhesive tapes on mineral surfaces. After curing, the result is a smooth, not permanently sticky film. The primer has a good heat bonding strength and good water-resistance.

APPLICATION

Typical mineral surfaces include cement fibre boards and plasterboards, stone, concrete, brick and lime / sand stone masonry as well as aerated concrete. In addition, ISO-TOP BLUE PRIMER can be used on fibrous surfaces such as soft fibre boards, wood composites, timber and other general construction materials.

PROCESSING

The surface must be dry, clean, smooth, able to bear a load, free of loose components, free of ice, frost, condensation, dust, oil and grease.

Stir / shake primer vigorously before use. Apply primer to the surface via open bottle cap (nozzle) and then distribute evenly using a brush or paint roller. Treat very porous surfaces twice if necessary. The preliminary coat must have

PRODUCT ADVANTAGES

- environmentally friendly, water based
- easy to process, solvent-free
- versatile use for standard construction surfaces
- wide range of applications
- fast-drying
- high proportion of solids
- simple to use
- no soiling of the adjacent areas
- extremely high yield

dried completely before further processing (flash-off time approx. 30 minutes). Make sure of even application. Thickened primer can be diluted with water.

PACKAGING

6 bottles (of 1,000ml) per box



Technical data	Standard	Classification
Colour		transparent in cured state
Base		aqueous acrylate-polymer latex
Density in g/cm ³ at +20°C	EN 542	approx. 1.04
Minimum processing temperature		construction materials and environment: from -8°C primer: from +5°C
Freeze-resistant		down to -26°C Acclimatise product before use at processing temperature. Do not heat quickly using heating devices.
Viscosity at +20°C	Brookfield 06 / 50 min ⁻¹	approx. 2,800 mPa.s
Flash-off time at +20°C / 50% RH		approx. 30 min
Application quantity		approx. 100g/m ² depending on the substrate
Shelf life		12 months in the original, unopened packaging
Storage temperature		+5°C to +25°C in dry environment without direct solar radiation

ISO-TOP SPRAY PRIMER



illustration purposes only

PRODUCT DESCRIPTION

ISO-TOP SPRAY PRIMER is a spray-on bonding agent based on synthetic rubber / resin. ISO-TOP SPRAY PRIMER was specially developed for preparing bonding surfaces for window connection foils, joint sealing tapes and multifunctional joint sealing tapes. The solvent-based ISO-TOP SPRAY PRIMER offers outstanding initial adhesion and fast-acting bonding characteristics. It is "ozone-friendly" and contains no chlorinated or fluorinated compounds. The swivelling spray nozzle can be turned for ease of application.

APPLICATION

ISO-TOP SPRAY PRIMER is ready for use and can be sprayed immediately. Typical mineral surfaces include concrete, brick, aerated concrete and lime / sand stone masonry. In addition, ISO-TOP SPRAY PRIMER can be used on surfaces such as wood, metal, rigid plastics, rubber, cork and other general construction materials.

PACKAGING

12 spray cans (of 500 ml) per box

PRODUCT ADVANTAGES

- chloride-free and fluoride-free
- versatile use for standard construction surfaces
- wide range of applications
- fast-drying
- simple to use
- extremely high yield
- excellent adhesive strength
- swivelling spray nozzle

Technical data	Standard	Classification
Colour		yellow
Base		synthetic rubber
Density in g/cm ³	EN 542	approx. 0.66
Application / can temperature		+5 °C to +35 °C
Processing / ambient temperature		-10 °C to +45 °C
Temperature stability range		-15 °C to +50 °C
Coverage		depending on the materials to be bonded / type of application, 500 ml will cover approximately approx. 5 m ²
Drying time*		2 to 5 minutes 3 to 5 minutes per coat for two coats Should be covered with final sealing material within 10 to 20 minutes.
Shelf life**		12 months in the original, unopened packaging
Storage temperature		+5 °C to +25 °C in dry environment without direct solar radiation

* Measured in accordance with DIN EN ISO 291 standard climate at 23 °C / 50% RH, values can vary due to environmental factors (temperature, moisture, surface).

** Storage: To prevent the spray nozzles becoming clogged, the cans must always be stored upright.

PROCESSING

Check compatibility with the surfaces before applying. The surface must be dry, clean, and free of dust, ice and frost.

Spray at a distance of 15 - 20cm from the surface; cover adjacent sensitive surfaces to protect them (curing time approx. 5 minutes). Treat highly porous surfaces twice if necessary. Protect the sprayed surface against moisture and soiling. After use, hold the can upside down and spray to remove residual primer and wipe any residues from the nozzle. The coverage is up to 5 m² depending on the surface and application.

SAFETY RECOMMENDATIONS

Always wear safety gloves and goggles when working with the material. Only use in well ventilated rooms. See the EC safety data sheet for more information.

ISO-TOP KSKSEAL PRIMER



PRODUCT DESCRIPTION

ISO-TOP KSKSEAL PRIMER is a solvent-free, high-quality, adhesion-enhancing preliminary coat on the basis of a bitumen emulsion for ISO-CONNECT KSKSEAL sealing membranes.

APPLICATION

ISO-TOP KSKSEAL PRIMER is suitable for preparing the surface of pours walls, floor slabs, foundations, balconies, underground car parks and patios, as well as other known and suitable mineral surfaces, before sealing with ISO-CONNECT KSKSEAL.

DIN 18195 Part 1-10 must always be observed for sealing work. In addition, the guidelines issued by the Deutsche Bauchemie e.V. (German construction chemical association) for the planning and execution of sealing work on components in contact with the ground and the guidelines of the Deutscher Ausschuss für Stahlbeton (DafStb German reinforced concrete committee) for the protection of concrete components and roofing guidelines must all be observed.

PACKAGING

60 units (of 5 l) per pallet

alternative sizes available on request

PRODUCT ADVANTAGES

- ready for use
- can be brushed, rolled and sprayed
- dries quickly
- environmentally friendly
- solvent-free

Technical data	Standard	Classification
Density in kg / l		approx. 1.0
Application- and hard-drying temperature*		+5 °C to +30 °C
Drying time**		approx. 45 minutes
Application quantity***		0.10l/m ² - 0.15l/m ²
Shelf life		at least 18 months with original seal, in a cool, dry and frost-free place

* Component, installation and ambient temperature.

** Measured in accordance with DIN EN ISO 291 standard climate at 23°C / 50 % RH, values can vary through environmental factors (temperature, moisture, surface).

*** The requirement data given are minimum values. These can increase depending on the workmanship during processing.

PROCESSING

Preparing the surface

The surface must be sufficiently dry, level, capable of bearing a load, frost-free, clean and free of oil, grease, tar, cavities, cracks, dust, dirt, residual mortar and other soiling. Edges must be rounded and smoothed with suitable materials

ISO-TOP KSKSEAL PRIMER is ready to use and is applied evenly to the cleaned surface by means of a swab, brush, roller or suitable spraying technique. ISO-TOP KSKSEAL PRIMER is thixotropic, which means it becomes more liquid like when agitated, e.g. stirred. It should be stirred thoroughly if it has been left to stand for a longer time.

Special notes

Protect the fresh primer coat from rain, frost and strong sunlight until it has hard-dried completely. Drying time approx. 45 minutes depending on the ambient temperature.

It is recommended to secure the upper edge of ISO-CONNECT KSKSEAL membrane mechanically with either a tension bar or adhesive strip to stop it peeling off. ISO-BUTYL FLEECE TAPE or a metal clamping bar are suitable for this purpose.

- Heed the safety data sheet
- Heed GISCODE BBP 10

ISO-BUTYL ALU TAPE

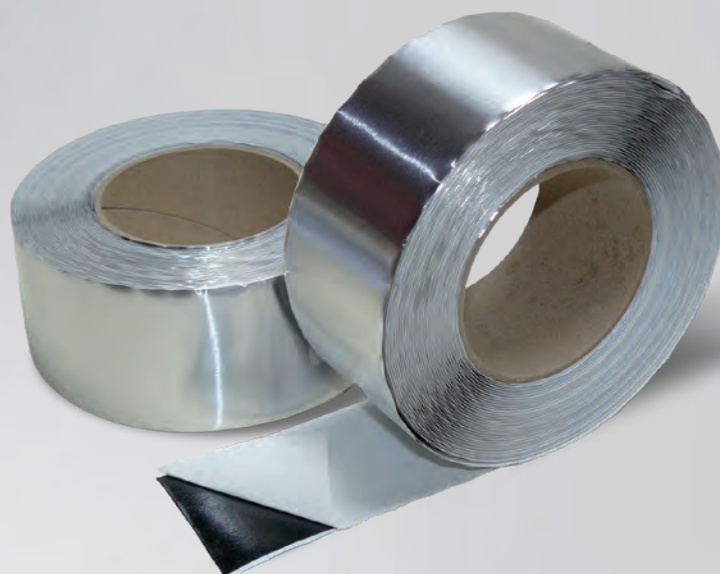

PRODUCT DESCRIPTION

ISO-BUTYL ALU TAPE is ideal for covering seals of construction and connecting joints in buildings and industry and for sealing both internal and external joints and overlaps (metalwork, container construction, conservatories, air-conditioning and ventilation construction). In addition, when used in the construction of windows and facades, ISO-BUTYL ALU TAPE is ideal for sealing connections and joints (where a gas and diffusionproof seal is necessary).

PROCESSING

Remove moisture, dust, separating agents, oil, grease and other dirt from surface to which the strip is to be applied. Pre-treat absorbent surfaces such as concrete, plaster, etc. with Primer. Unroll strip and cut to length. Adhere the adhesive butyl surface of ISO-BUTYL ALU TAPE to the pre-treated substrate using a pressure roller. Press down firmly and carefully. Avoid creases and bends when pressing down or roll out carefully. Avoid transverse installations in roof areas (danger of detachment due to snow and ice loads).

PRODUCT ADVANTAGES

- water-repellent
- does not cause corrosion
- solvent-free
- bitumen-free and bitumen-compatible
- resistant to aging, weathering and UV
- constant volume
- functions immediately and simple to use
- permanent adhesion
- complies with IVD instruction leaflet No. 5

Technical data	Standard	Classification
Material description		butyl rubber aluminium / plastic compound film
Building material class		B2
Colour		black / aluminium
Density in g/cm ³	DIN EN ISO 10563	≥ 1.6
Slipping test		stable
sd-value	DIN EN ISO 12572	> 1.500m
Temperature stability range	DIN 52455-4	-40°C to +90°C
Working temperature		approx. +5°C to +30°C
Storage temperature		approx. 20°C practically unlimited (rolls stored flat, dry and protected from dust)

Thickness x width	Roll length (metres)	Carton (metres)
0.8x50mm	10.0	120.0
0.8x100mm	10.0	40.0
0.8x150mm	10.0	40.0

ISO-CONNECT KSKSEAL



PRODUCT DESCRIPTION

ISO-CONNECT KSKSEAL is an all-over self-adhesive, flexible sealing membrane made of polymer-modified bitumen with a flexible yet tearproof HDPE foil and is used for the external sealing of window and door elements in facade constructions. ISO-CONNECT KSKSEAL protects components in contact with the ground permanently against non-pressurised water as per DIN 18533 for sealing thresholds, ground moisture and non-accumulating seepage water.

APPLICATION

ISO-CONNECT KSKSEAL has been designed for the correct physical external sealing of bottom joints on doors and floor-length windows to the perimeter area.

FINISHES

Completely self-adhesive with separate release paper:

- 100 – 200 mm width with a longitudinal perforation
- 250 – 300 mm width with two longitudinal perforations
- 350 mm width with three longitudinal perforations

PRODUCT ADVANTAGES

- can be installed all year round
- no hard-drying necessary
- immediately resistant to water and driving rain
- no waiting times
- flexible, resilient and crack-covering
- highly resistant to all aggressive substances which naturally occur in soil
- perforated release paper for easier fitting
- 10 Year Function Warranty*

* On the conditions of the manufacturer (available on request).

DIMENSIONS

width: 100, 150, 200, 250, 300, 350 mm
further widths and thicknesses available on request

PACKAGING

rolls, roll length: 20 m

Technical data	Standard	Classification
Material description		polymer-modified bitumen on tear-resistant HDPE
Colour		black
Building material class	DIN EN 13501	E
Bitumen compatibility	DIN 7864 T1	bitumen compatible
UV stability		approx. 5 months
Water vapour diffusion resistance μ		168,500 / sd-value 252 m
Material thickness		1.5 mm
Handling temperature		-5°C to +30°C
Dimensional tolerance	DIN 7715 TP P3	DIN EN 1848-1 fulfilled
Storage temperature		+5°C to +30°C stored in a vertical position
Shelf life		12 months

PREPARATION

Unroll the ISO-CONNECT KSKSEAL sealing foil and cut it to the required length. The area to be bonded must be clean, dry, free of solvents, greases, dust, oil and other anti-adhesive substances.

PROCESSING

Always treat the mineral area to be bonded with ISO-TOP KSKSEAL PRIMER and then apply the self-adhesive backing to the area to be bonded/sealed and press into place carefully using a roller so that the product is moulded to the contours of the substrate. On the top edge of the seal a flashing strip (ISO-BUTYL FLEECE TAPE) may be required. Additional mechanical fixing, e.g. supporting lath, clamping bar and fastening to the window, should, as specified in DIN 18531 and DIN 18533, be mounted. Also observe any notes in the installation instructions.

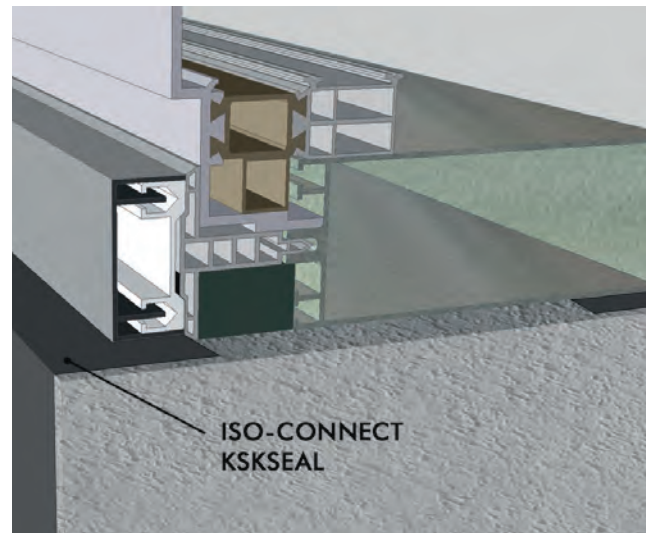

Installation example: ISO-CONNECT KSKSEAL

ISO-TOP POWER-TAPE

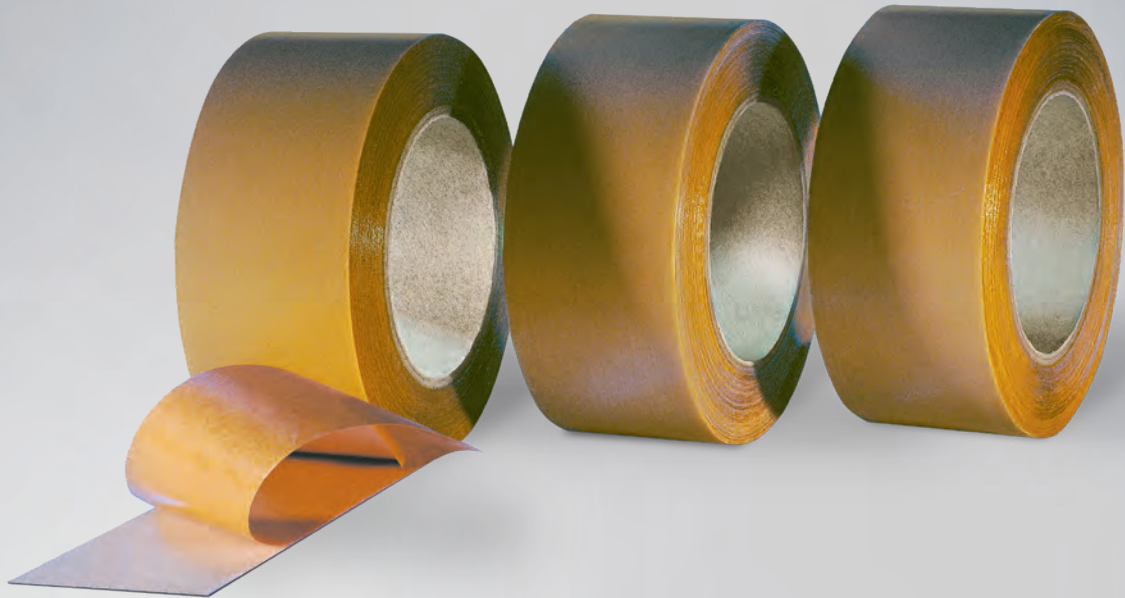

PRODUCT DESCRIPTION

ISO-TOP POWER-TAPE is a sodium paper equipped with highly adhesive acrylate dispersion on one side. ISO-TOP POWER-TAPE is suitable for air tight bonding of roof underlays in accordance to DIN 4108-7.

APPLICATION

ISO-TOP POWER-TAPE provides reliable bonding for vapour barrier foils and is suitable for use on different finishes:

- plastic
- fleece
- paper

and creates a strong bond between these materials.

SERVICE

- standard requirements available from stock
- private label and / or special labelling available
- competent experienced technical support available in the field and by phone

PACKAGING

rolls, one-side self-adhesive

- roll width: 60 mm
- number of rolls (per box): 10
- roll length (metres): 40 m
- box (metres): 400 m

PRODUCT ADVANTAGES

- complies with the requirements of DIN 4108-7 for vapour tight connections
- air tight bonding of foils
- optimum connections on overlaps
- very good bonding on standard vapour barrier foils and roof underlays
- free from softening agents and halogens
- constant quality, DIN-standards which are regularly examined by external institutions



Technical data	Standard	Classification
Material description		single-sided, self-adhesive sodium paper
Adhesive base		solvent-free acrylate dispersion
Adhesive carrier		power paper (yellow)
Paper cover		silicone paper (brown)
Adhesive strength	DIN EN 1939	approx. 35 N/25 mm
Thickness		approx. 0.32 mm (without paper cover)
Applied adhesive		approx. 200 g/m ²
Temperature stability range		-40°C to +100°C
Aging resistance		very good
Handling temperature		from -10°C
Dimension tolerance	DIN 7715 T5 P3	requirements fulfilled
Shelf life		1 year, dry and in original packing
Storage temperature		+10°C to +20°C

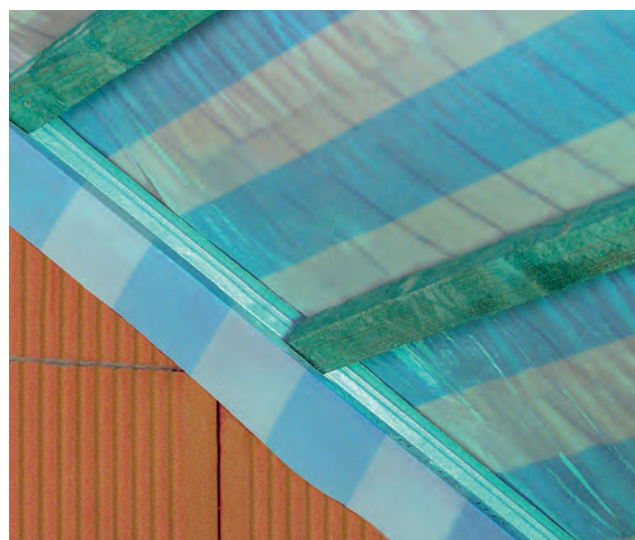
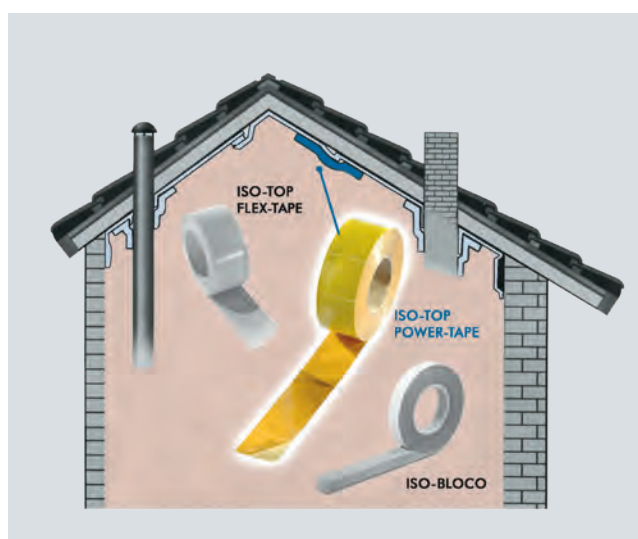

Installation example: ISO-TOP POWER-TAPE

ISO-TOP FLEX-TAPE

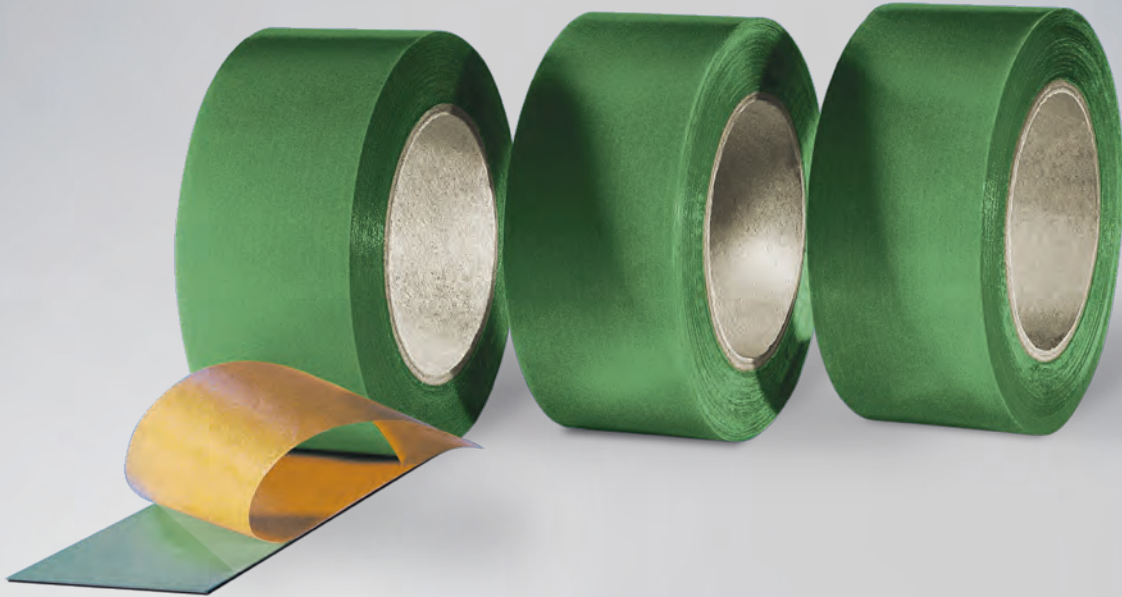

PRODUCT DESCRIPTION

ISO-TOP FLEX-TAPE is a LDPE tape equipped with a very strong acrylate dispersion adhesive on one side. ISO-TOP FLEX-TAPE is a suitable all round sealing in accordance with DIN 4108-7.

APPLICATION

ISO-TOP FLEX-TAPE provides reliable bonding for vapour barrier foils and is suitable for use on different finishes:

- plastic
- fleece
- paper

It creates a secure bond between foil and surface, for example on concrete and masonry work. ISO-TOP FLEX-TAPE adheres perfectly to smooth surfaces, providing an air tight bond.

SERVICE

- standard requirements available from stock
- private label and / or special labelling available
- competent experienced technical support available in the field and by phone

PACKAGING

rolls, one-side self-adhesive

PRODUCT ADVANTAGES

- complies with the requirements of the DIN 4108-7 for vapour tight connections
- air tight bonding of foils to adjoining building constructions
- very good adhesion to standard vapour barrier foils and roof tile underlays
- air tight finish on openings
- free from softening agents and halogens
- constant quality, DIN-standards which are regularly examined by external institutions



Technical data	Standard	Classification
Material description		single-sided, self-adhesive LDPE tape
Adhesive base		solvent-free acrylate dispersion
Adhesive carrier		LDPE-film (green)
Intermediate adhesive carrier		polyester lining
Paper cover		silicone paper (brown)
Adhesive strength	Afera 5001	ø 37 N / 25 mm
Thickness		approx. 0.32 mm (without paper cover)
Applied adhesive		approx. 230 g / m ²
Temperature stability range		-40°C to +80°C
Aging resistance		very good
sd-value	DIN 53122-1 DIN EN 1931	approx. 25 m
Handling temperature		from -10°C
Dimension tolerance	DIN 7715 T5 P3	requirements fulfilled
Shelf life		1 year, dry and in original packing
Storage temperature		+10°C to +20°C

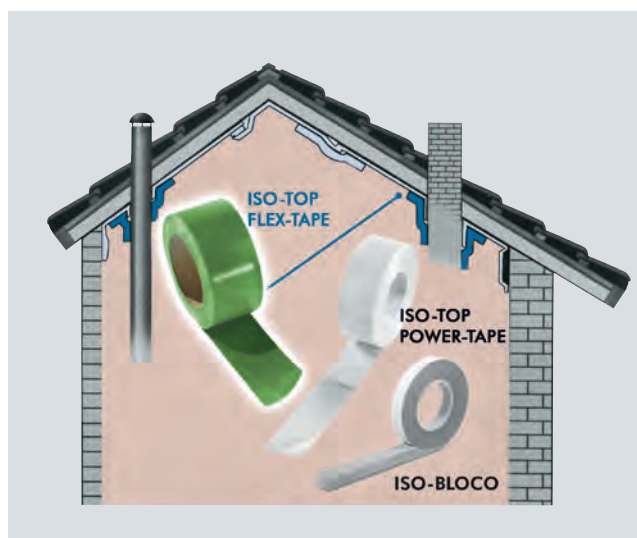

Tape width	Roll length (metres)	Carton (metres)
40 mm	25.0	350.0
50 mm		300.0
60 mm		250.0
70 mm		200.0
80 mm		250.0
90 mm		150.0
100 mm		150.0
110 mm		250.0
120 mm		250.0
130 mm		100.0
140 mm		100.0
150 mm		100.0

ISO-FLAME KOMBI F 120

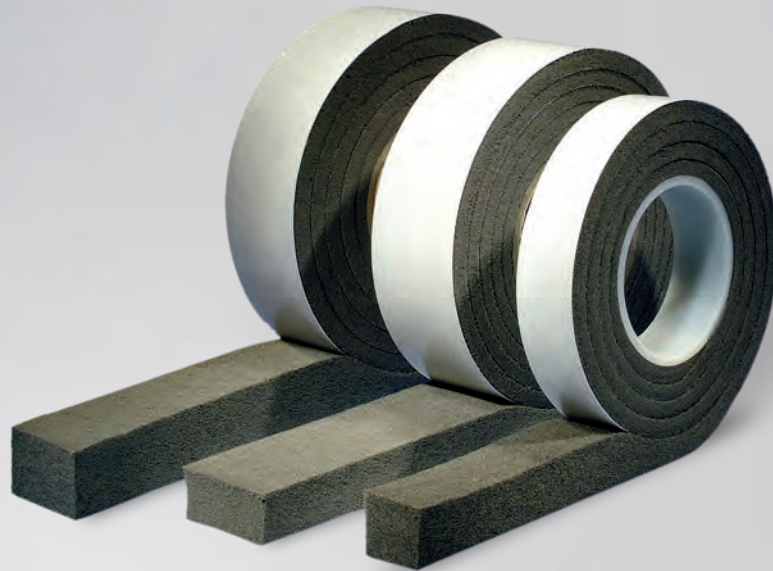

PRODUCT DESCRIPTION

ISO-FLAME KOMBI F 120 is a PUR-sealing tape equipped with a special highly fire resistant impregnation for fire protection joints. It fulfils the requirements of DIN 4102 for F 120 and DIN EN 13501-2 for EI 120 and is characterised for its simple and reliable application.

APPLICATION

ISO-FLAME KOMBI F 120 is suitable for the reliable sealing of joints and connections in buildings, which must provide high fire protection requirements. Its usages range from sealing fire protection joints in walls, ceilings and connections between wall and ceiling (up to a fire resistance period of 120 minutes) through to building segments such as:

- solid constructions
- pre-fabricated constructions
- wall partitioning constructions
- timber constructions EI 30
- metal constructions EI 30
- weather-proof joints in connection with ISO-BLOCO 600 and 300 as well as ISO-TOP FACADE SEAL

SERVICE

- standard sizes available from stock
- competent experienced technical support available in the field and by phone

PRODUCT ADVANTAGES

- fulfils the requirements of fire protection as a physical barrier against the flame and thermal isolation for 120 minutes (F 120 and EI 120)
- fire resistance period of F 30, F 120, EI 30 and EI 120 tested by iBMB / MPA Braunschweig and MPA Stuttgart
- permanently elastic, with a high long term movement capacity
- for joint dimensions from 4 up to 40 mm
- sound and heat insulating
- approved, tested coverage with ISO-BLOCO 300 and 600 as well as ISO-TOP FACADE SEAL
- no pre-treatment of the joint and no additional sealing to the visible joint surface with fire protection compound agent required
- applicable in all types of construction
- constant quality, DIN-standardised, which are regularly controlled by independent institutions
- 10 Year Function Warranty*

* On the conditions of the manufacturer (available on request).

PACKAGING

pre-compressed rolls with one-sided intumescent (expands in case of fire) self-adhesive (assists application)



Technical data	Standard	Classification
Material description		impregnated PUR-soft foam
Base		acrylate with flame retarding additives
Colour		anthracite
Self-adhesive foil		intumescent foil (expands in case of fire)
Test certificate / suitability proof		P-3436/5813 – MPA BS, PB 2400/157/15 – Rue (MPA BA) and 903 3814 000/La (MPA Stuttgart)
Fire resistance period	BS EN 13501-2 DIN 4102-1	EI 30 to EI 120 F 30 to F 120
Behaviour in case of fire	DIN 4102 T1 BS EN 13501-1	B1 (flame resistant) E
Dimension tolerance	DIN 7715 T5 P3	requirements fulfilled
ETA - 18/0378		CE mark since 2018
Shelf life		1 year, dry and in original packing
Storage temperature		+5°C to +20°C

area of application joint width*	wall EI 30	ceiling EI 30	wall & ceiling EI 120	ceiling EI 120	timber wall EI 30	metal wall EI 30	Roll length (metres)
4 – 6 mm							7.0
5 – 8 mm							5.6
7 – 10 mm							6.0
10 – 14 mm	2 x 30 mm**	1 x 40 mm**	2 x 40 mm**	1 x 80 mm**	2 x 25 mm**	2 x 30 mm**	4.5
12 – 20 mm							4.0
18 – 28 mm							2.6
22 – 40 mm		1 x 50 mm**	2 x 50 mm**	1 x 100 mm**	2 x 30 mm**		2.1

Alternative dimensions available on request.

* Movement in the structure and temporary longitude changes are to be taken into account when determining the max. joint width.

** Number of pieces x tape width ISO-FLAME KOMBI F120.

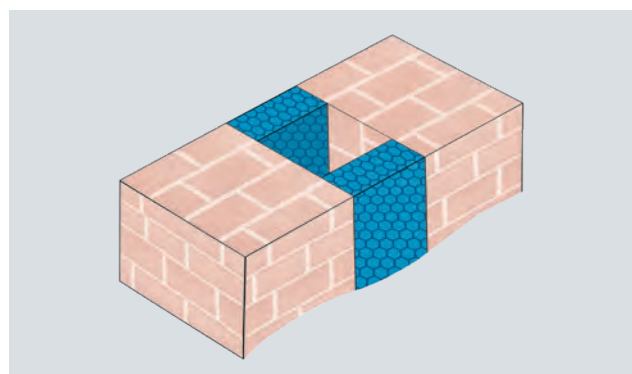

Installation example: ISO-FLAME KOMBI F120

ISO-FLAME BRICK S 90

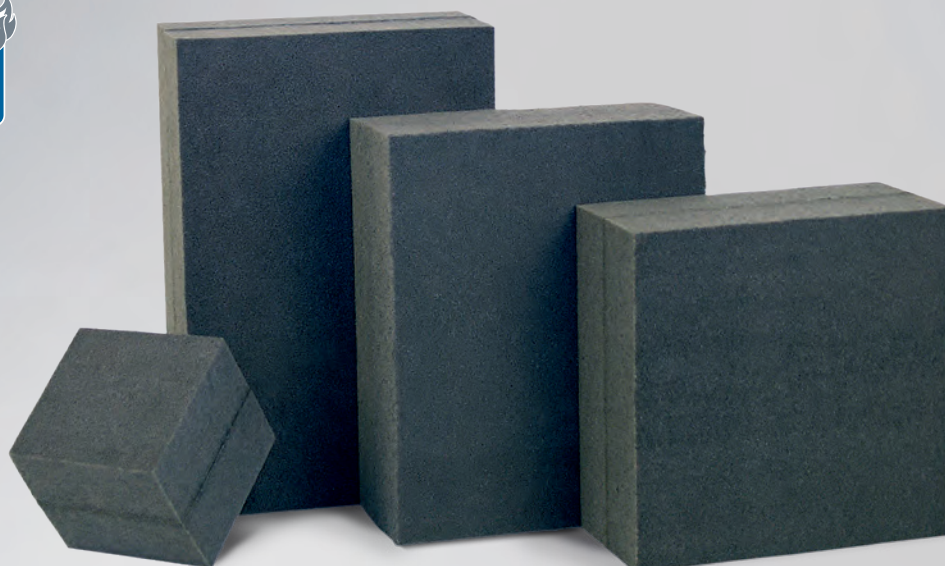

PRODUCT DESCRIPTION

ISO-FLAME BRICK S 90 is a fire resistant impregnated PUR-high resilient foam form for fire-protection of single cables, cable bundles and pipes (service fire-stops). It is used in rectangular and irregular fire wall openings in accordance to DIN 4102 for the F-Classes S 30, S 60 and S 90. Its maximum fire resistance durability averages at 90 minutes.

APPLICATION

ISO-FLAME BRICK S 90 is certified for the fire-stop protection of wall and ceiling openings, when fire rating classification S 30, S 60 or S 90 is required, in accordance with DIN 4102 T.9. It is particularly suitable, due to it being totally fibre and dust free, for use in dirt sensitive areas. The spectrum of uses extends from fire protection walls and ceilings, of concrete, reinforced concrete, cellular concrete and brick-work to lighter partitioning walls.

The fitting of single cables, cable bundles, pipes and cable looms is simply done by cutting.

INSTALLATION

- coat either the wall aperture edges or the ISO-FLAME BRICK edges with ISO-FLAME KITT to bond the foam in place
- on ceiling openings both visible fire-stop surfaces are to be coated with ISO-FLAME KITT (this is optional on walls)
- the relevant building approval should be sort for using the ISO-FLAME BRICK S 90 as the services fire stop

PRODUCT ADVANTAGES

- quick and clean application without special tools (very economical)
- no preparation of the wall or ceiling opening necessary
- easy fitting of cables
- totally free from dust and fibres
- flexible application (temporary and permanent cable insulation)
- toxic fume blocker
- no cracking due to permanent elasticity with high flexibility
- free from halogens and solvents
- 10 Year Function Warranty*

* On the conditions of the manufacturer (available on request).

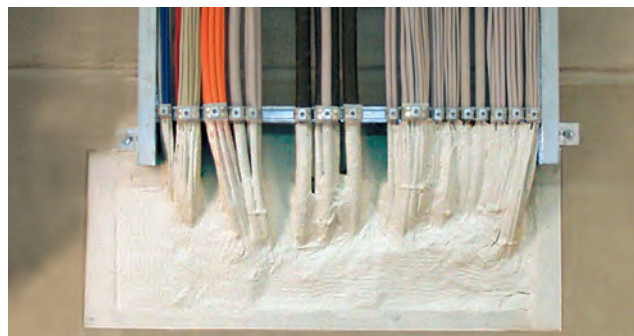

Installation example: ISO-FLAME BRICK S 90

Technical data: BRICK		Standard	Classification
Material description			fire resistant impregnated PUR-flexible foam
Colour			anthracite
Fire resistance durability in fire protection walls and ceilings		DIN 4102 T.9	S90
General construction technique permit			aBG Z-19.53-2364
Handling temperature			+5°C to +40°C
Temperature stability range, dry			-40°C to + 80°C
Building material class		DIN 4102 T.1	B2
Dimension tolerance		DIN 7715 T5 P3	requirements fulfilled
Shelf life			1 year
Technical data: KITT		Standard	Classification
Material description			paste-like, endothermic fire protection compound
Colour			white
Density in g/cm ³			approx. 1.34 to 1.48
Fire resistance durability in fire protection walls and ceilings		DIN 4102 T.9	S90 in combination with ISO-FLAME BRICK
Handling temperature			+5°C to +25°C
Drying time			dust-dry after approx. 4 h, completely dry depending on layer thickness after a maximum of 4 days
Shelf life			2 years

SYSTEM ACCESSORIES

- ISO-FLAME KITT – fire protection kitt (FLAMMOTECT-A) ablative fire protection compound (paste consistency) ETA-18/0237

PACKAGING ISO-FLAME KITT

- buckets of 12.5 kg / 12 cartridges (of 310 ml) per box
- consumption depends on the installation situation

TECHNICAL APPROVAL

general construction technique permit through DIBt Berlin for S90 aBG Z-19.53-2364

LxWxH = Ordner no.	Achieved F-Class*	Minimum wall and ceiling thickness	Bricks per carton
475x475x90 mm	up to S90	100 mm (wall) and 150 mm (ceiling)	4
475x160x90 mm	up to S90	100 mm (wall) and 150 mm (ceiling)	12
160x160x90 mm	up to S90	100 mm (wall) and 150 mm (ceiling)	36

* For fire protection class S90 the minimum thickness of the fire-stop is 200 mm. 2 bricks per opening must be installed. The size of the fire-stop should be maximum 95% of the foam form.

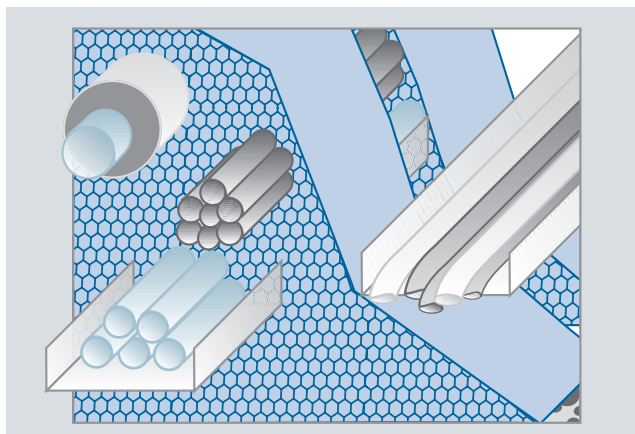

Installation example: ISO-FLAME BRICK S90

Fitting	Wall (mm)	Ceiling (mm)
Maximum size of the fire-stop		
rectangular	450x450	450x450
irregular	450x450	-
Minimum distance to next fire-stop	100	100
Maximum amount of cables	60%	60%
Maximum cable diameter	30	30
Maximum metal duct diameter	114	54

ISO-FLAME PLUG S 90



PRODUCT DESCRIPTION

ISO-FLAME PLUG S 90, is a specially developed form for a quick, easy and clean fitting for fire protection of single cables, cable bundles on circular openings (e. g. core hole) in fire walls and ceilings in accordance to DIN 4102.

It consists of fire resistant impregnated PUR high resilient foam and is designed for a maximum fire resistance durability up to 90 minutes.

APPLICATION

ISO-FLAME PLUG S 90 is suitable for fire-stop protection in wall and ceiling openings where fire protection rating S 30, S 60 or S 90 is required, in accordance with DIN 4102 T.9.

It is particularly suitable for fire protection walls and ceilings of concrete and / or reinforced concrete, cellular concrete, brick-work or lighter partitioning walls. The fitting of cables is simply done by cutting.

INSTALLATION

- coat either the wall aperture edges or the ISO-FLAME BRICK edges with ISO-FLAME KITT to bond the foam in place
- on ceiling openings both visible fire-stop surfaces are to be coated with ISO-FLAME KITT (this is optional on walls)
- the relevant building approval should be sort for using the ISO-FLAME PLUG S 90 as the services fire stop

PRODUCT ADVANTAGES

- quick and clean application (very economical)
- totally free from dust and fibres
- easy fitting of cables
- no special tools for fitting required or preparation of wall and ceiling openings necessary
- toxic fume blocker
- flexible application (temporary and permanent cable insulation)
- no cracking due to permanent elasticity with high flexibility
- free from halogens and solvents
- 10 Year Function Warranty*

* On the conditions of the manufacturer (available on request).

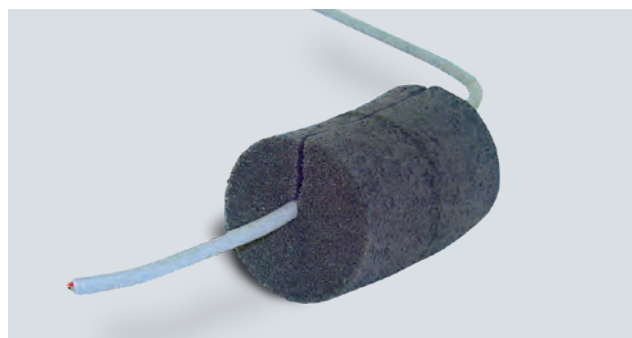

PATENTED

Technical data: PLUG		Standard	Classification
Material description			fire resistant impregnated PUR-flexible foam
Colour			anthracite
Fire resistance durability in fire protection walls and ceilings		DIN 4102 T.9	S90
General construction technique permit			aBG Z-19.53-2364
Handling temperature			+5°C to +40°C
Temperature stability range, dry			-40°C to + 80°C
Building material class		DIN 4102 T.1	B2
Dimension tolerance		DIN 7715 T5 P3	requirements fulfilled
Shelf life			1 year
Technical data: KITT		Standard	Classification
Material description			paste-like, endothermic fire protection compound
Colour			white
Density in g/cm ³			approx. 1.34 to 1.48
Fire resistance durability in fire protection walls and ceilings		DIN 4102 T.9	S90 in combination with ISO-FLAME PLUG
Handling temperature			+5°C to +25°C
Drying time			dust-dry after approx. 4 h, completely dry depending on layer thickness after a maximum of 4 days
Shelf life			2 years

SYSTEM ACCESSORIES

- ISO-FLAME KITT – fire protection kitt (FLAMMOTECT-A) ablative fire protection compound (paste consistency) ETA-18/0237

PACKAGING ISO-FLAME KITT

- buckets of 12.5 kg / 12 cartridges (of 310 ml) per box
- consumption depends on the installation situation

TECHNICAL APPROVAL

general construction technique permit through DIBt Berlin for S90 aBG Z-19.53-2364

Dia. xH = Ordner no.	Max. hole diameter	Achieved F-Class*	Minimum wall- and ceiling thickness	Plugs per carton
54x90mm	51 mm	up to S90	100 mm (wall) and 150 mm (ceiling)	30
62x90mm	58 mm	up to S90	100 mm (wall) and 150 mm (ceiling)	30
74x90mm	70 mm	up to S90	100 mm (wall) and 150 mm (ceiling)	18
85x90mm	80 mm	up to S90	100 mm (wall) and 150 mm (ceiling)	12
100x90mm	95 mm	up to S90	100 mm (wall) and 150 mm (ceiling)	12
115x90mm	109 mm	up to S90	100 mm (wall) and 150 mm (ceiling)	12
130x90mm	123 mm	up to S90	100 mm (wall) and 150 mm (ceiling)	12
151x90mm	143 mm	up to S90	100 mm (wall) and 150 mm (ceiling)	12
181x90mm	175 mm	up to S90	100 mm (wall) and 150 mm (ceiling)	12

* For the fire protection S 90 the minimum thickness of the fire-stop is 200 mm. 2 plugs per openings must be installed.

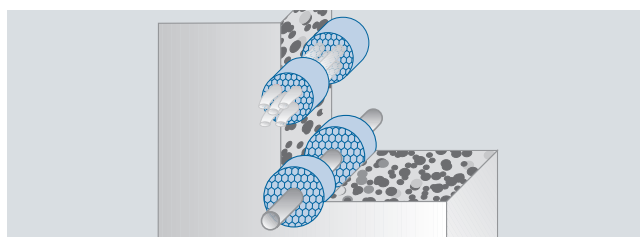

Installation example: ISO-FLAME PLUG S90

Fitting	Wall (mm)	Ceiling (mm)
Minimum distance to next fire-stop	100	100
Maximum amount of cables	60%	60%
Maximum cable diameter	30	30
Maximum metal duct diameter	114	54

ISO-BLOCO FILLER

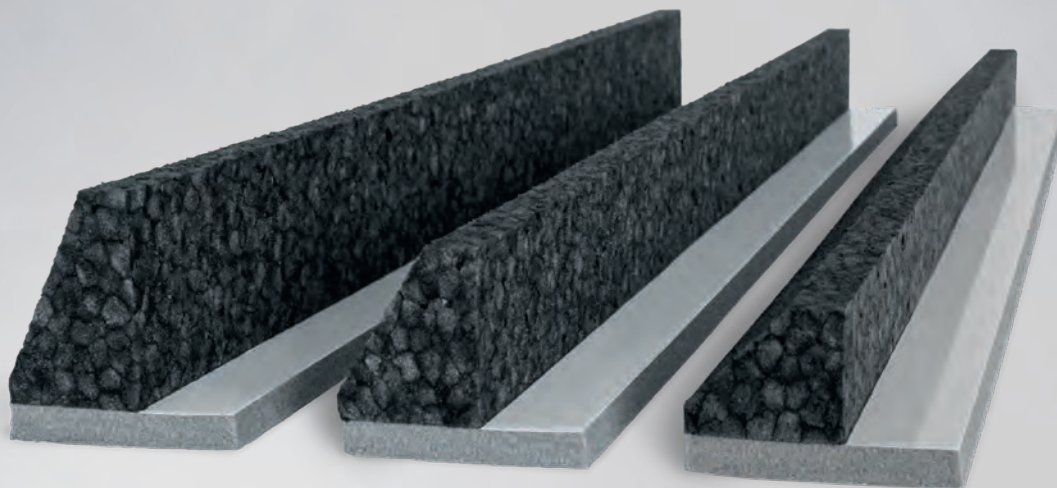

PRODUCT DESCRIPTION

ISO-BLOCO FILLER is a multi-functional insulation and sealing system which has been developed especially for window fitting in cavity walls. It is fitted in the gap between the inner wall and outer faced brickwork.

It is made up of two functional components:

One of these is a filler block made of highly elastic special foam. This forms the basis for sealing the window against the building and seals the gap between the window and the cavity wall aperture. The high elasticity of the filler block guarantees a firm fit and makes the air tight closure of the masonry opening possible, which is necessary in order to conform with window sealing standards.

The second component of the sealing system is a sealing bar made of impregnated foam which guarantees sealing of the window frame against the outer wall and protects the window connection joint securely against the influence of the weather in the rebate area.

PACKAGING

ISO-BLOCO FILLER sealing profile bars

PRODUCT ADVANTAGES

- simple fitting, conforming to window sealing standards in cavity walls
- ideal for “check reveal” situation
- high adaptation to “check reveals” of up to 30%
- integrated sealing tape system for sealing the weather protection level
- flexible adaptation to unevenness of the inner wall
- complies with the requirements of the Building Energy Act (EnEV was vaild 31.10.20) and the recommendations of the RAL “installation guide”



Installation example: ISO-BLOCO FILLER

PATENTED

Technical data	Standard	Classification
Sealing bar:		
Material description		sealing bar made of impregnated PUR soft foam
Colour		grey-anthracite
Classified according to	DIN 18542	BG 1
Air permeability coefficient	DIN EN 12114	$\alpha < 1.0 \text{ m}^3 / [\text{h} \cdot \text{m} \cdot (\text{daPa})^n]$
Impermeable to driving rain	DIN EN 1027	$\geq 600 \text{ Pa}$
Temperature stability range	DIN 18542	-30 °C to +90 °C
Compatibility with adjacent building materials	DIN 18542	requirements fulfilled
Building material class	DIN 4102	B1 (fire resistant)
Thermal conductivity	DIN EN 12667	$\lambda = 0.052 \text{ W/m} \cdot \text{K}$
Water vapour diffusion resistance μ	DIN EN ISO 12572	≤ 100
sd-value	DIN EN ISO 12572	$< 0.5 \text{ m}$ at 50mm width (breathable)
Dimensional tolerance (sealing bar and filler block)	DIN 7715 T5 P3	requirements fulfilled
Shelf life (sealing bar and filler block)		2 years, stored dry and in original packaging
Storage temperature (sealing bar and filler block)		+1 °C to +20 °C
Filler block profile:		
Material description		highly elastic filler block profile
Density filler block profile in kg/m^3		22 +/-
Compression strength – filler block		at 25% compression 30kPa following DIN EN ISO 844 at 50% compression 80kPa following DIN EN ISO 844
Building material class	DIN EN 13501	E
Thermal conductivity	DIN EN 12667	$\lambda = 0.040 \text{ W/m} \cdot \text{K}$

APPLICATION

ISO-BLOCO FILLER is a perfect solution, in accordance with the window sealing standards, for sealing windows against masonry in cavity walls, both in new buildings and where windows are being refurbished. The insulation and sealing system is pressed directly into the opening between the inner and outer wall cavity before the window is fitted. ISO-BLOCO FILLER is pressed into position. Permanent positioning is then guaranteed due to the high elasticity of the material. The material creates an air tight seal, thus forming an ideal solution for a check reveal situation. If the connection surfaces are extremely uneven, any gaps can be closed using injected sealing agents.

The ISO-BLOCO FILLER can be used all the way round the cavity. In the corners the special fill block is butt jointed.

The remaining joint between the window frame and ISO-BLOCO FILLER can then be sealed according to the 3-level principle e. g. using the multi-functional joint sealing strip ISO-BLOCO ONE or using another joint sealing solution in line with generally accepted technical guidelines.

DIMENSIONS

Type description	Format	For gaps from – to	For rebate joints up to	For rebate widths up to	Carton (metres)
ISO-BLOCO FILLER 40 / 60	1,000x60x60mm	60 – 40 mm	6 mm	45 mm	36
ISO-BLOCO FILLER 60 / 80	1,000x60x80mm	80 – 60 mm	6 mm	45 mm	27
ISO-BLOCO FILLER 80 / 100	1,000x60x100mm	100 – 80 mm	6 mm	45 mm	27

ISO-ZELL PE- AND PUR-CORD



PRODUCT DESCRIPTION

ISO-ZELL PE-CORD is a round seal, which fulfils the requirements of the DIN 18540 for backfill material on expanding joints. It consists of closed cellular polyethylene foam and is suitable for sealing against drafts and heat loss.

ISO-ZELL PE-CORD provides a reliable backfill on building joints and is characterised through its excellent compatibility with all standard sealing materials. Used as a backing support for sealants, 3-sided adhesion can be effectively eliminated.

APPLICATION

ISO-ZELL PE- and PUR-CORD are particularly suitable for plugging and as backfill material for sound absorption and sealing of:

- cavity filling
- construction and variable joints
- joint sealant
- U-Profile glass sealing

Due to its water-resistant surface ISO-ZELL PE-CORD can be used in both interior and exterior areas as backfill material. The neutral product properties and the closed cellular surface also make it suitable to use with porous materials.

PRODUCT ADVANTAGES

- fulfils the requirements of the DIN 18540 for backfill material on expanding joints
- PE-CORD tested to GEV-EMICODE®, certified as very low-emission (EC1^{PLUS})
- suitable for damp joints
- water and moisture resistant
- also suitable with porous materials
- minimises the joint depth and eliminates the 3-sided adhesion on back filled sealants (silicon, acryl, PUR etc.)
- compatible with all standard sealants (silicon, acryl etc.)
- elastic, flexible
- free from softeners
- ageing resistant

SERVICE

- standard sizes available from stock
- private label and / or special labelling available
- competent experienced technical support available in the field and by phone

PACKAGING

- 6 – 30 mm diameter: endless coils
- 40 – 50 mm diameter: 1 or 2 m long pieces



Technical data	Standard	Classification
ISO-ZELL PE-CORD		
Material description		closed-celled PE foam
Colour		grey
Building material class	DIN 4102	B2
Density in kg/m ³	DIN 53420	30
Tensile-strength	DIN 53571	320 kPa
Elongation	DIN 53571	approx. 170%
Compression at 40%	DIN 53577	85 kPa
Water absorption	DIN 53428	≤ 1%
Temperature stability range	internal	approx. -40°C to approx. +60°C
Dimension tolerance	DIN 7715 T5 P3	requirements fulfilled
Shelf life		1 year, dry and in original packing
Storage temperature		+5°C to +20°C
ISO-ZELL PUR-CORD		
Material description		open-celled PUR foam
Colour		grey
Building material class	DIN 4102	B2
Density in kg/m ³	DIN EN ISO 845*	20 +/- 4
Tensile-strength	DIN EN ISO 1798*	≥ 100 kPa
Elongation	DIN EN ISO 1798*	≥ 60%
Temperature stability range	internal	approx. -40°C to approx. +60°C
Dimension tolerance	DIN 7715 T5 P3	requirements fulfilled
Shelf life		1 year, dry and in original packing
Storage temperature		+5°C to +20°C

* In compliance with the relevant standards / test specifications / internal monitoring.

PREPARATION

Compress the ISO-ZELL PE- and PUR-CORD and insert in to the joint or cavity. Push it in until the desired joint depth is reached. For the joint to conform to DIN 18540, avoid stretching the cord when installing it and ensure any butt joints meet exactly. To avoid damage to the material it should not be installed using pointed instruments.

ISO-ZELL PUR-CORD

- characteristics: ISO-ZELL PUR-CORD is an open cellular polyurethane foam
- application: ISO-ZELL PUR-CORD is ideal as backfill material in internal joints which are not exposed to moisture
- form of delivery: 1 m long pieces, diameter: 15 – 50 mm

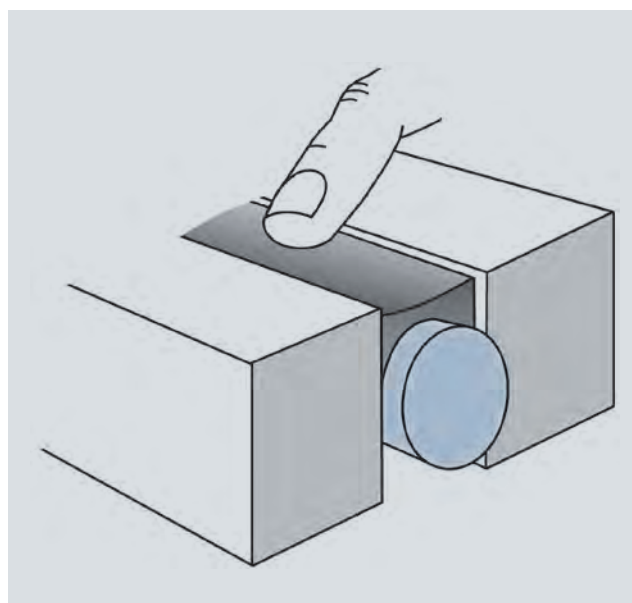

Installation example: ISO-ZELL PE-CORD



ISO-TOP PRESSFIX

PRODUCT DESCRIPTION

The ISO-TOP PRESSFIX aluminium tube press with nylon union nut and rubber-coated handle for a safe grip and comfortable handling. Especially for use with construction adhesives and sealants in up to 600 ml tubes.

ESPECIALLY SUITABLE FOR:

- ISO-TOP FLEX-ADHESIVE HP
- ISO-TOP FLEX-ADHESIVE SP
- ISO-TOP FLEX-ADHESIVE XP
- ISO-TOP FLEX-ADHESIVE WF



ISO-TOP EASYPRESS

PRODUCT DESCRIPTION

The high-quality ISO-TOP EASYPRESS metal skeleton hand press for use with adhesives and sealants in PE plastic cartridges. Non-twist hexagon thrust rod with integrated hook and automatic run-on and end-stop function.

ESPECIALLY SUITABLE FOR:

- ISO-TOP FLEX-ADHESIVE PA



ISO-TOP EASYPRESS PRO

PRODUCT DESCRIPTION

The professional ISO-TOP EASYPRESS PRO is a high-quality hand press for applying adhesives and sealants in 310 ml cartridges. Half-shell press with rotating shell and strong thrust block, rubberised handle and transmission ratio of 17:1.

ESPECIALLY SUITABLE FOR:

- ISO-TOP FLEX-ADHESIVE PA



ISO-TOOL CLIP

PRODUCT DESCRIPTION

For the simple and fast pre-fitting of ISO-BLOCO ONE CONTROL (variant with clip attachment) on the frame of PVC and aluminium windows.

ESPECIALLY SUITABLE FOR:

ISO-BLOCO ONE CONTROL



ISO-TOOL CUT

PRODUCT DESCRIPTION

Our special blade for reliable corner-shaping of ISO-BLOCO ONE CONTROL.

ESPECIALLY SUITABLE FOR:

ISO-BLOCO ONE CONTROL

ISO³-WINDOW SEALING SYSTEM

AIRTIGHTNESS, INSULATION AND WEATHER PROTECTION ALL FROM A SINGLE SOURCE

Our ISO³-WINDOW SEALING SYSTEM includes a range of window connection films for time-saving and air tight sealing, as well as permanently elastic, impregnated PUR sealing tapes which serve as weather protection as well as being used for thermal and acoustic insulation. In addition, we can also supply in front of wall installation systems and our multi-functional joint sealing tapes combine all three functions in one product. Furthermore we also supply sealants and PUR-foams.



ISO³-FACADE SEALING SYSTEM

INNOVATIVE JOINT SEAL FOR FACADES, ROOFS AND INTERIOR FITTINGS

Facade joints are exposed to extreme stresses caused by the weather influences and building design. You can rely on the products from ISO³-FACADE SEALING SYSTEM, which offer a long-lasting, reliable and energy saving seal for structural facade elements.



ISO^M-METAL BUILDING SEALING SYSTEM

THE FIRST IFBS-TESTED SEALING SYSTEM FOR LIGHT-GAUGE METAL STRUCTURES

Light-gauge metal joint constructions are exposed to many climatic and mechanical stresses. This demands a joint sealing system that is able to withstand the relevant building design requirements such as thermal insulation, airtightness, acoustic insulation and moisture-protection, fire protection and temperature fluctuations.



ISO^F-FIRE PROTECTION SYSTEM

PATENTED FIREPROOF PARTITION SYSTEMS FOR FACADES, JOINTS AND OPENINGS IN WALLS AND CEILINGS

Fire protection is a central component of building safety. In the event of a fire, our fire protection system guarantees to prevent the spread of fire and smoke and the components will remain stable for a specified period. All fire protection products are subject to regular internal and external controls.

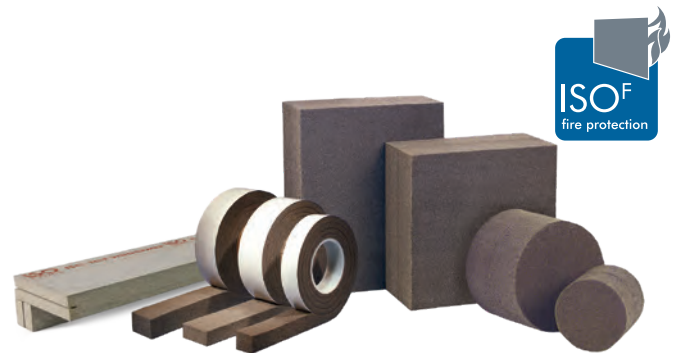

ISO^μ-TIMBER SEALING SYSTEM

EFFECTIVE PROTECTION FROM ENERGY COSTS AND STRUCTURAL DAMAGE

Our ISO^μ-TIMBER SEALING SYSTEM makes the sealing of moving joints simple and reliable. This is because our quality-tested system products compensate joint movements safely, and at the same time are optimised for use as a humidity and vapour barrier. This is necessary because joints in timber constructions are subject to heavy loads.



ISO^E-EWI SEALING SYSTEM

THE SEALING SYSTEM FOR SPECIAL ENERGY SAVING

Our ISO^E-EWI SEALING SYSTEM contains all the sealing components required for the simple and secure connection of external thermal insulation composite systems (EWI) to building openings and projections. It is has been optimised particularly for the straightforward, secure and fast connection of EWI elements to windows and doors as well as in the roof and base areas, thus enabling you to meet all structural-physical requirements professionally without any problems at all.



NOTES





The details and information given in this literature are based on best current knowledge. They are intended to serve as general information only and it is advised that the user conducts their own tests for their specific set of conditions to determine the suitability of the product for its proposed use. No warranty or liability is given or implied regarding any part of these instructions or details, or the completeness of the information. We reserve the right to modify, or change, the specifications and information without advance notification. All goods are supplied subject to our standard conditions of sales, copies of which are available upon request.

The latest technical information on the individual products can be found under www.iso-chemie.co.uk

Use the blue technology.



ISO-Chemie GmbH

Germany

Röntgenstraße 12
73431 Aalen
Tel.: +49 (0)7361 94 90-0
Fax: +49 (0)7361 94 90 90
info@iso-chemie.de
www.iso-chemie.de

France

Tel.: +33 (0)4 78 34 89 75
Fax: +33 (0)4 78 34 87 72
info@iso-chemie.fr
www.iso-chemie.fr

United Kingdom

Tel.: +44 (0)1207 56 68 67
Fax: +44 (0)1207 56 68 69
info@iso-chemie.co.uk
www.iso-chemie.co.uk

Italy

Tel.: +39 02947 56 159
Fax: +39 02947 56 160
info@iso-chemie.it
www.iso-chemie.it

Poland

Tel.: +48 71 88 10 048
Fax: +48 71 88 10 049
info@iso-chemie.pl
www.iso-chemie.pl